

# Magellan™ 3500HSi Omni-Directional Imaging Scanner

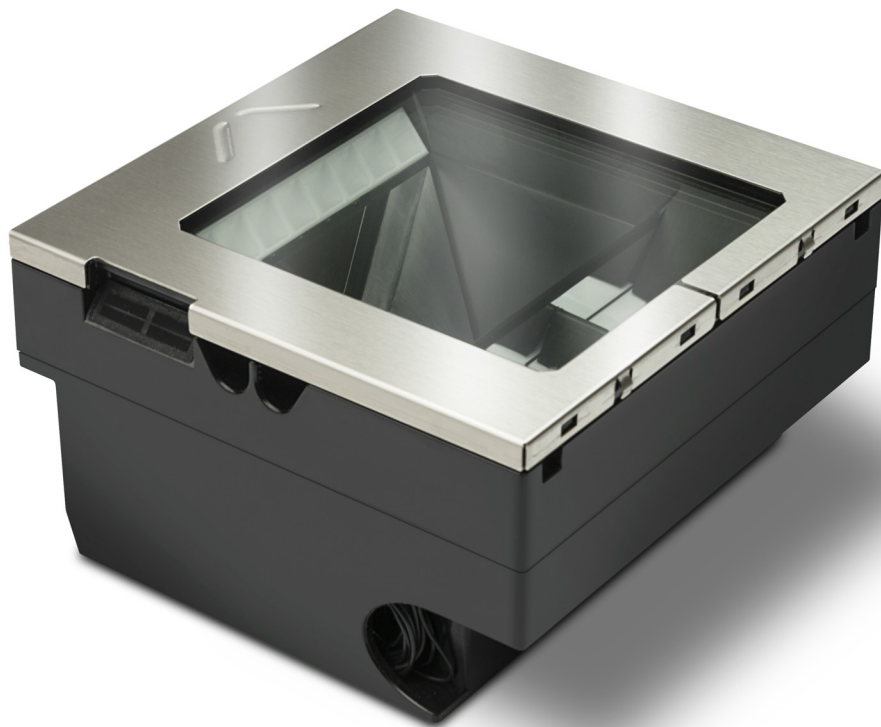

**Datalogic S.r.l.**

Via S. Vitalino, 13  
40012 Calderara di Reno — Italy  
Tel. +39 051 3147011  
Fax +39 051 3147205

© 2016-2019 Datalogic S.p.A. and/or its affiliates

An Unpublished Work - All rights reserved. No part of the contents of this documentation or the procedures described therein may be reproduced or transmitted in any form or by any means without prior written permission of Datalogic S.p.A. and/or its affiliates. Owners of Datalogic products are hereby granted a non-exclusive, revocable license to reproduce and transmit this documentation for the purchaser's own internal business purposes. Purchaser shall not remove or alter any proprietary notices, including copyright notices, contained in this documentation and shall ensure that all notices appear on any reproductions of the documentation.

Should future revisions of this manual be published, you can acquire printed versions by contacting your Datalogic representative. Electronic versions may either be downloadable from the Datalogic website ([www.datalogic.com](http://www.datalogic.com)) or provided on appropriate media. If you visit our website and would like to make comments or suggestions about this or other Datalogic publications, please let us know via the "Contact Datalogic" page.

**Disclaimer**

Datalogic has taken reasonable measures to provide information in this manual that is complete and accurate, however, Datalogic reserves the right to change any specification at any time without prior notice.

Datalogic and the Datalogic logo are registered trademarks of Datalogic S.p.A. in many countries, including the U.S.A. and the E.U.

Magellan is a trademark of Datalogic S.p.A. or of Datalogic and/or its affiliates, registered in many countries, including the U.S. and the E.U.

**Patents**

See [www.patents.datalogic.com](http://www.patents.datalogic.com) for patent list.



# Table of Contents

<b>Chapter 1. GETTING STARTED</b> .....	<b>1</b>
<b>About This Manual</b> .....	<b>1</b>
Manual Conventions .....	1
<b>Connecting the Scanner</b> .....	<b>2</b>
<b>Scanner Features</b> .....	<b>4</b>
<b>Chapter 2. PROGRAMMING</b> .....	<b>5</b>
<b>Introduction to Label Programming</b> .....	<b>5</b>
<b>Understanding the Basics</b> .....	<b>5</b>
Using the Programming Bar Codes .....	5
Resetting the Standard Product Defaults .....	6
Using a Bar Code Mask .....	7
Going Green .....	7
<b>Bar Code Mask</b> .....	<b>8</b>
<b>GENERAL SCANNER FEATURES</b> .....	<b>9</b>
<b>1D Double Read Timeout</b> .....	<b>10</b>
<b>2D Double Read Timeout</b> .....	<b>11</b>
<b>Digital Watermark (Digimarc®) Features</b> .....	<b>12</b>
Digital Watermark (Digimarc) Enable .....	12
Digital Watermark (Digimarc) Double Read Timeout .....	13
Digital Watermark (Digimarc) Data Format .....	14
<b>Sleep Mode Timer</b> .....	<b>15</b>
<b>1D Inverse Read Control</b> .....	<b>16</b>
<b>2D Inverse Read Control</b> .....	<b>17</b>
<b>Reading Illumination Duration</b> .....	<b>18</b>
<b>Power On Alert</b> .....	<b>19</b>
<b>Illumination During Disable Mode</b> .....	<b>20</b>
<b>Object Sense Control</b> .....	<b>21</b>
<b>Exposure Control</b> .....	<b>22</b>
<b>External Read Indicator (ERI)</b> .....	<b>23</b>
<b>ERI Timeout</b> .....	<b>24</b>
<b>Good Read LED Idle State</b> .....	<b>25</b>
<b>Scanner Control Button Options</b> .....	<b>26</b>
<b>Good Read Beep Control</b> .....	<b>27</b>
<b>Good Read Beep Frequency</b> .....	<b>28</b>
<b>Good Read Beep Length</b> .....	<b>29</b>
<b>Good Read Beep Volume</b> .....	<b>30</b>
<b>Good Read When to Indicate</b> .....	<b>31</b>
<b>Host Download To Handheld</b> .....	<b>32</b>
Handheld Host Download Timeout .....	32
<b>IMAGING FEATURES</b> .....	<b>33</b>
<b>Imaging Features</b> .....	<b>34</b>

Image Capture to the Host by Host Command .....	34
Cell Phone Mode .....	35
Cell Mode Percent .....	36
Picture Retrieval Timeout .....	37
Image Capture Delay .....	39
Image Format .....	40
Image Size .....	41
Image Brightness .....	42
Image Contrast .....	44
Image Compression .....	46
Region of Interest (ROI) .....	47
<b>INTERFACE RELATED FEATURES.....</b>	<b>49</b>
<b>Interface Type .....</b>	<b>50</b>
USB-COM Interface Setup .....	51
RS-232 Interface Selection .....	51
USB Interface Selection .....	52
Keyboard Interface Selection .....	53
Maximum Host-Transmitted Message Length .....	54
<b>RS-232 Interface Features .....</b>	<b>55</b>
RS-232 Baud Rate .....	55
RS-232 Number of Data Bits .....	57
RS-232 Number of Stop Bits .....	57
RS-232 Parity .....	58
RS-232 Hardware Control .....	59
RS-232 Intercharacter Delay .....	60
RS-232 Software Flow Control .....	61
RS-232 Beep on ASCII BEL .....	62
Beep on Not on File .....	62
RS-232 ACK NAK Features .....	63
ACK NAK Enable .....	63
RS-232 ACK Character .....	64
RS-232 NAK Character .....	65
RS-232 Retry on ACK NAK Timeout .....	66
RS-232 ACK NAK Timeout Value .....	67
RS-232 ACK NAK Retry Count .....	68
RS-232 ACK NAK Error Handling .....	69
RS-232 Indicate Transmission Failure .....	70
RS-232 Ignore Host Commands .....	71
<b>USB-OEM Interface Features .....</b>	<b>72</b>
USB OEM Scanner Device Type .....	72
USB OEM Additional Interface Options .....	73
<b>USB Keyboard Features .....</b>	<b>74</b>
Keyboard Layout .....	74
USB Keyboard Country Mode .....	74
USB Keyboard Caps Lock State .....	77
No Keyboard Support .....	78
USB Keyboard Send Control Characters .....	79
Quiet Interval .....	80
USB Keyboard Intercharacter Delay .....	81
USB Keyboard Additional Interface Options .....	82
<b>DATA EDITING.....</b>	<b>83</b>
<b>Data Editing Overview .....</b>	<b>84</b>
Please Keep In Mind... .....	84
<b>Global Prefix/Suffix .....</b>	<b>85</b>

Global Prefix .....	85
Global Suffix .....	86
<b>AIM ID .....</b>	<b>87</b>
<b>Label ID .....</b>	<b>88</b>
Label ID Control .....	88
Setting Label ID .....	89
1D Symbolologies .....	90
2D Symbolologies .....	95
Global Mid-Label ID .....	96
<b>Case Conversion .....</b>	<b>97</b>
<b>Character Conversion .....</b>	<b>98</b>
<b>1D SYMBOLOGY PROGRAMMING.....</b>	<b>99</b>
<b>1D Symbolologies .....</b>	<b>99</b>
<b>Coupon Control .....</b>	<b>100</b>
Coupon Control Enable .....	100
Coupon Label Priority Timer .....	101
<b>UPC-A .....</b>	<b>102</b>
UPC-A Enable .....	102
UPC-A Number System Character Transmission .....	103
UPC-A Check Character Transmission .....	104
UPC-A Minimum Read .....	105
Expand UPC-A to EAN-13 .....	106
<b>UPC-E .....</b>	<b>107</b>
UPC-E Enable .....	107
UPC-E Number System Character Transmission .....	108
UPC-E Check Character Transmission .....	109
Expand UPC-E to UPC-A .....	110
Expand UPC-E to EAN-13 .....	111
UPC-E Minimum Read .....	112
<b>EAN-13 .....</b>	<b>113</b>
EAN-13 Enable .....	113
EAN-13 First Character Transmission .....	114
EAN-13 Check Character Transmission .....	115
EAN-13 ISBN Conversion Enable .....	116
EAN-13 Minimum Read .....	117
<b>EAN-8 .....</b>	<b>118</b>
EAN-8 Enable .....	118
EAN-8 Check Character Transmission .....	119
Expand EAN-8 to EAN-13 .....	120
EAN-8 Minimum Read .....	121
EAN-8 Guard Insertion .....	122
EAN-8 Guard Substitution .....	123
EAN-8/Jan-8 Both Guards Substitution .....	124
EAN-8 Stitch Exact Label Halves .....	125
EAN-8 Stitch Unlike Label Halves .....	126
EAN-8 Minimum Segment Length .....	127
EAN-8 Decoding Levels .....	129
<b>Other UPC/EAN Options .....</b>	<b>130</b>
In-Store Printed Label Minimum Read .....	130
UPC/EAN Correlation .....	131
UPC/EAN Guard Insertion .....	132
UPC/EAN Stitch Exact Label Halves .....	133
UPC/EAN Stitch Unlike Label Halves .....	134
UPC/EAN Minimum Segment Length .....	135
Price Weight Check .....	137

Enable EAN Two Label .....	139
EAN Two Label Minimum Read .....	140
EAN Two Label Combined Transmission .....	141
Add-ons .....	142
P2 Add-on Minimum Read .....	143
P5 Add-on Minimum Read .....	146
UPC/EAN Composites .....	149
<b>GTIN .....</b>	<b>150</b>
GTIN Enable .....	150
<b>GS1 DataBar .....</b>	<b>151</b>
<b>DataBar Omnidirectional .....</b>	<b>151</b>
DataBar Omnidirectional Enable .....	151
DataBar Omnidirectional/EAN-128 Emulation .....	152
DataBar Omnidirectional 2D Component Enable .....	153
DataBar Omnidirectional Minimum Read .....	154
DataBar Omnidirectional Double Read Timeout .....	155
<b>DataBar Limited .....</b>	<b>156</b>
DataBar Limited Enable .....	156
DataBar Limited Minimum Read .....	157
DataBar Limited 2D Component Enable .....	158
DataBar Limited EAN128 Emulation Enable .....	159
<b>DataBar Expanded .....</b>	<b>160</b>
DataBar Expanded Enable .....	160
DataBar Expanded EAN-128 Emulation .....	161
DataBar Expanded 2D Component Enable .....	162
DataBar Expanded Minimum Read .....	163
DataBar Expanded Length Control .....	164
DataBar Expanded Length 1 .....	165
DataBar Expanded Length 2 .....	166
DataBar Expanded Reverse Retry .....	167
<b>Code 39 .....</b>	<b>168</b>
Code 39 Enable .....	168
Code 39 Start Stop Character Transmission .....	169
Code 39 Check Character Calculation .....	170
Code 39 Check Character Transmission .....	171
Code 39 Full ASCII .....	172
Code 39 Minimum Read .....	173
Code 39 Correlation .....	174
Code 39 Length Control .....	175
Code 39 Length 1 .....	176
Code 39 Length 2 .....	177
Code 39 Stitching .....	178
Code 39 Require Margins .....	179
<b>Code 32 Italian Pharmacode .....</b>	<b>180</b>
Code 32 Italian Pharmacode Enable .....	180
Code 32 Start Stop Character Transmission .....	181
Code 32 Check Character Transmission .....	182
<b>Code 128 .....</b>	<b>183</b>
Code 128 Enable .....	183
Code 128 Transmit Function Characters .....	184
Expand Code128 to Code 39 .....	185
Code 128 Minimum Read .....	186
Code 128 Correlation .....	187
Code 128 Length Control .....	188
Code 128 Length 1 .....	189

Code 128 Length 2 .....	190
Code 128 Stitching .....	191
<b>EAN-128 .....</b>	<b>192</b>
EAN-128 Enable .....	192
<b>Interleaved 2 of 5 (I 2 OF 5) .....</b>	<b>193</b>
Interleaved 2 of 5 (I 2 OF 5) Enable .....	193
I 2 of 5 Check Character Calculation .....	194
I 2 of 5 Check Character Transmission .....	195
I 2 of 5 Minimum Read .....	196
I 2 of 5 Correlation .....	197
I 2 of 5 Length Control .....	198
I 2 of 5 Length 1 .....	199
I 2 of 5 Length 2 .....	200
I 2 of 5 Stitching .....	201
<b>Codabar .....</b>	<b>202</b>
Codabar Enable .....	202
Codabar Start Stop Character Transmission .....	203
Codabar Start Stop Character Set .....	204
Codabar Start Stop Character Match .....	205
Codabar Check Character Calculation .....	206
Codabar Check Character Transmission .....	207
Codabar Minimum Read .....	208
Codabar Correlation .....	209
Codabar Length Control .....	210
Codabar Length 1 .....	211
Codabar Length 2 .....	212
Codabar Stitching .....	213
Codabar Require Margins .....	214
<b>Code 93 .....</b>	<b>215</b>
Code 93 Enable .....	215
Code 93 Minimum Read .....	216
Code 93 Correlation .....	217
Code 93 Length Control .....	218
Code 93 Length 1 .....	219
Code 93 Length 2 .....	220
Code 93 Stitching .....	221
<b>MSI .....</b>	<b>222</b>
MSI Enable .....	222
MSI Check Character Calculation .....	223
MSI Number of Check Characters .....	224
MSI Check Character Transmission .....	225
MSI Minimum Read .....	226
MSI Correlation .....	227
MSI Length Control .....	228
MSI Length 1 .....	229
MSI Length 2 .....	230
MSI Stitching .....	231
<b>Standard 2 of 5 .....</b>	<b>232</b>
Standard 2 of 5 Enable .....	232
Standard 2 of 5 Check Character Calculation .....	233
Standard 2 of 5 Check Character Transmission .....	234
Standard 2 of 5 Minimum Read .....	235
Standard 2 of 5 Correlation .....	236
Standard 2 of 5 Length Control .....	237
Standard 2 of 5 Length 1 .....	238

Standard 2 of 5 Length 2 .....	239
Standard 2 of 5 Stitching .....	240
<b>2D SYMBOLOGIES/BAR CODES .....</b>	<b>241</b>
<b>Data Matrix .....</b>	<b>242</b>
Data Matrix Enable .....	242
Data Matrix Length Control .....	243
Configuring Variable Length Decoding: .....	243
Data Matrix Length 1, Length 2 Programming Instructions .....	244
GS1 Datamatrix Enable .....	245
<b>PDF 417 .....</b>	<b>246</b>
PDF 417 Enable .....	246
PDF 417 Length Control .....	247
Configuring Variable Length Decoding: .....	247
PDF 417 Length 1, Length 2 Programming Instructions .....	248
PDF 417 Read Option .....	249
<b>Micro PDF 417 .....</b>	<b>250</b>
Micro PDF 417 Enable .....	250
Micro PDF 417 Length Control .....	251
Configuring Variable Length Decoding: .....	251
Micro PDF 417 Length 1, Length 2 Programming Instructions .....	252
Micro PDF 417 128 Emulation .....	253
<b>QR Code .....</b>	<b>254</b>
QR Code Enable .....	254
QR Code Length Control .....	255
Configuring Variable Length Decoding: .....	255
QR Code Length 1, Length 2 Programming Instructions .....	256
QR Code URL Link Enable .....	257
<b>GS1 QR Code Enable .....</b>	<b>258</b>
<b>Micro QR Code .....</b>	<b>259</b>
Micro QR Code Enable .....	259
Micro QR Code Length Control .....	260
Configuring Variable Length Decoding: .....	260
Micro QR Code Length 1, Length 2 Programming Instructions .....	261
<b>Aztec Code .....</b>	<b>262</b>
Aztec Enable .....	262
Aztec Length Control .....	263
Configuring Variable Length Decoding: .....	263
Aztec Length 1, Length 2 Programming Instructions .....	264
<b>Chapter 3. REFERENCES .....</b>	<b>265</b>
<b>Global Prefix/Suffix .....</b>	<b>265</b>
<b>Label ID .....</b>	<b>266</b>
Length Control .....	267
Configuring Variable Length Decoding: .....	268
Length 1, Length 2 Programming Instructions .....	268
<b>Appendix A. PRODUCT SPECIFICATIONS .....</b>	<b>269</b>
<b>Decoding Capability .....</b>	<b>269</b>
<b>Electrical .....</b>	<b>269</b>
<b>Environmental .....</b>	<b>270</b>
<b>Interfaces .....</b>	<b>270</b>
<b>Optional Features .....</b>	<b>270</b>
<b>Physical Characteristics .....</b>	<b>271</b>
Scanner Dimensions .....	271
<b>Reading Performance .....</b>	<b>272</b>



Safety & Regulatory .....	272
Utilities .....	272
Warranty .....	272
LED and Beeper Indicators .....	273
Error Codes .....	274
<b>Appendix B. CABLE PINOUTS .....</b>	<b>275</b>
Standard Cable Pinouts (Primary Interface Cables) .....	275
<b>Appendix C. ALPHA-NUMERIC KEYPAD.....</b>	<b>276</b>
<b>Appendix D. FACTORY DEFAULT SETTINGS .....</b>	<b>278</b>
Factory Default Settings .....	278
<b>Appendix E. KEYBOARD FUNCTION KEY MAPPINGS.....</b>	<b>292</b>
USB Function Key Usage Map .....	292
<b>Appendix F. HOST COMMANDS.....</b>	<b>298</b>
Accepting RS-232 Commands .....	298
<b>Appendix G. SAMPLE SYMBOLS.....</b>	<b>299</b>
1D Symbol Samples .....	299
2D Sample Symbols .....	301
Composite Sample Symbols .....	302
<b>Appendix H. MICROSD CARD .....</b>	<b>303</b>
<b>microSDHC Compatibility .....</b>	<b>303</b>
microSD Card Insertion .....	303
microSD Card Removal .....	304
<b>Autorun File Processing .....</b>	<b>304</b>
<b>microSD Function Summary .....</b>	<b>305</b>
<b>microSD Function Details .....</b>	<b>305</b>
From Scanner to microSD Card .....	305
Export a Configuration file from the Scanner to the microSD card .....	305
From microSD Card to Scanner .....	306
Application code load to scanner .....	306
Configuration load to scanner .....	306
<b>Appendix I. HANDHELD DATA FORMAT REQUIREMENTS .....</b>	<b>307</b>
<b>Handheld Data Format Requirements General .....</b>	<b>307</b>
Datalogic Handheld Data Format Requirements .....	307
GS1 DataBar Omnidirectional .....	307
GS1 DataBar Expanded .....	307
UPC-A .....	308
UPC-A with 2-Digit Supplemental .....	308
UPC-A with 5-Digit Supplemental .....	308
UPC-E .....	308
UPC-E with 2-Digit Supplemental .....	308
UPC-E with 5-Digit Supplemental .....	308
EAN-8 .....	308
EAN-8 with 2-Digit Supplemental .....	309
EAN-8 with 5-Digit Supplemental .....	309
EAN-13 .....	309
EAN-13 with 2-Digit Supplemental .....	309
EAN-13 with 5-Digit Supplemental .....	309

---

Code 39 .....	309
Code 39-Pharmacode .....	309
I 2 of 5 .....	310
Codabar .....	310
Code 128 .....	310
MSI .....	310
Code 93 .....	311
PDF417 .....	311
AIM Formats .....	311
UPC-A .....	311
UPC-E .....	311
EAN-13 .....	311
EAN-8 .....	311
2-Digit Supplemental .....	312
5-Digit Supplemental .....	312
Bookland .....	312
Code 39 .....	312
Codabar .....	312
MSI .....	313
Code 93 .....	313
RSS-14 .....	313
RSS Expanded .....	313
I 2 of 5 .....	313
Code 128 / EAN128 .....	313
PDF417 .....	314
'Unknown" AIM ID (an AIM ID which is not specified above) .....	314



# Chapter 1

## Getting Started

The Magellan™ 3500HSi In-Counter Presentation Scanner is designed for small counter retail checkout environments where there is a relatively high number of transactions with a fairly small number of items per transaction. The scanner enables both high speed sweep and presentation scanning techniques, ensuring maximum productivity and ergonomic ease.

### About This Manual

This manual provides advanced user information, including connection, programming, product and cable specifications, and other useful references. For additional information, such as installation, maintenance, troubleshooting and warranty information, see the Quick Reference Guide (QRG). Copies of other publications for this product are downloadable free of charge from the website listed on the back cover of this manual.

On leaving the factory, units are programmed for the most common terminal and communications settings. If you need to change these settings, custom programming can be accomplished by scanning the bar codes in this guide. The most common default settings for features/options are indicated by a green arrow.

### Manual Conventions

The symbols listed below are used in this manual to notify the reader of key issues or procedures that must be observed when using the scanner.



**NOTE**

**Notes contain information necessary for properly diagnosing, repairing and operating the scanner.**



**CAUTION**

**The CAUTION symbol advises you of actions that could damage equipment or property.**

---

## Connecting the Scanner

The scanner kit you ordered to match your interface should provide a compatible cable for your installation. Alternatively, if your scanner receives Power Off the Terminal (POT) it might be possible to connect using a cable from a previously existing installation (except for USB). For Powering Off Terminal (POT), please reference Electrical Specifications in Appendix A to ensure your Host Terminal's power supply is compatible, or contact Datalogic Technical Support. If you wish to connect using an existing cable, but cannot use POT, a short adapter cable is available. Check with your technical support representative about compatibility before connecting. Use the appropriate instructions below when you're ready to connect the scanner to the terminal, PC or other host device.

Upon completing the connection via the appropriate interface instructions below, proceed to the [Interface Related Features](#) section of this manual and scan the bar code to select the correct interface type.

**RS-232 Serial Connection** — Turn off power to the terminal/PC and connect the scanner to the terminal/PC serial port via the RS-232 cable as shown in [Figure 1](#). If the terminal will not support POT (Power Off the Terminal) to supply scanner power, use the approved power supply (AC Adapter).

**Figure 1. Connecting the Scanner**

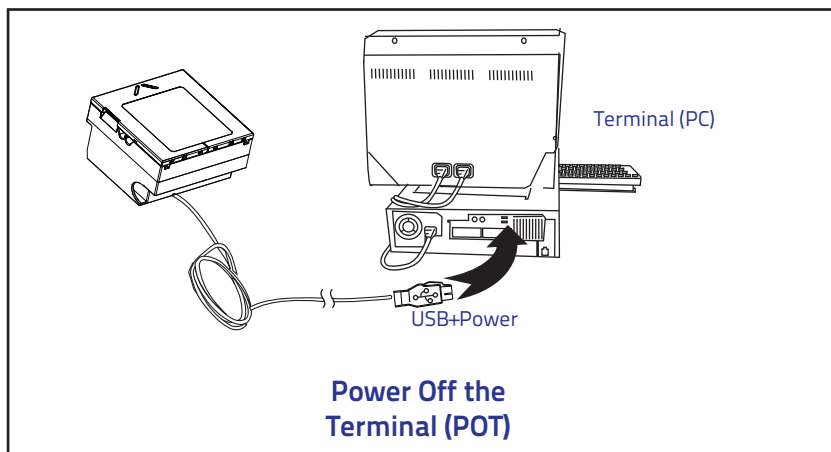
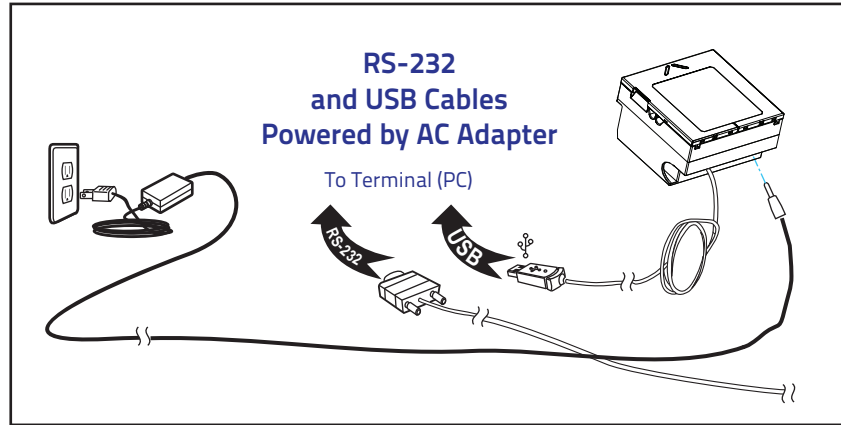

Figure 2. Connecting with AC Adapter.



**USB Connection** — Connect the scanner to a USB port on the terminal/PC using the correct USB cable for the interface type you ordered. Reference [Figure 1](#) and [Figure 2](#).



**NOTE**

USB installations may require a power connection via an approved A/C Adapter as shown in [Figure 1](#). For example, this would be the case if the scanner is connected along with a number of other devices to a non-powered USB hub.

# Scanner Features

Figure 3. Scanner Features - Front View

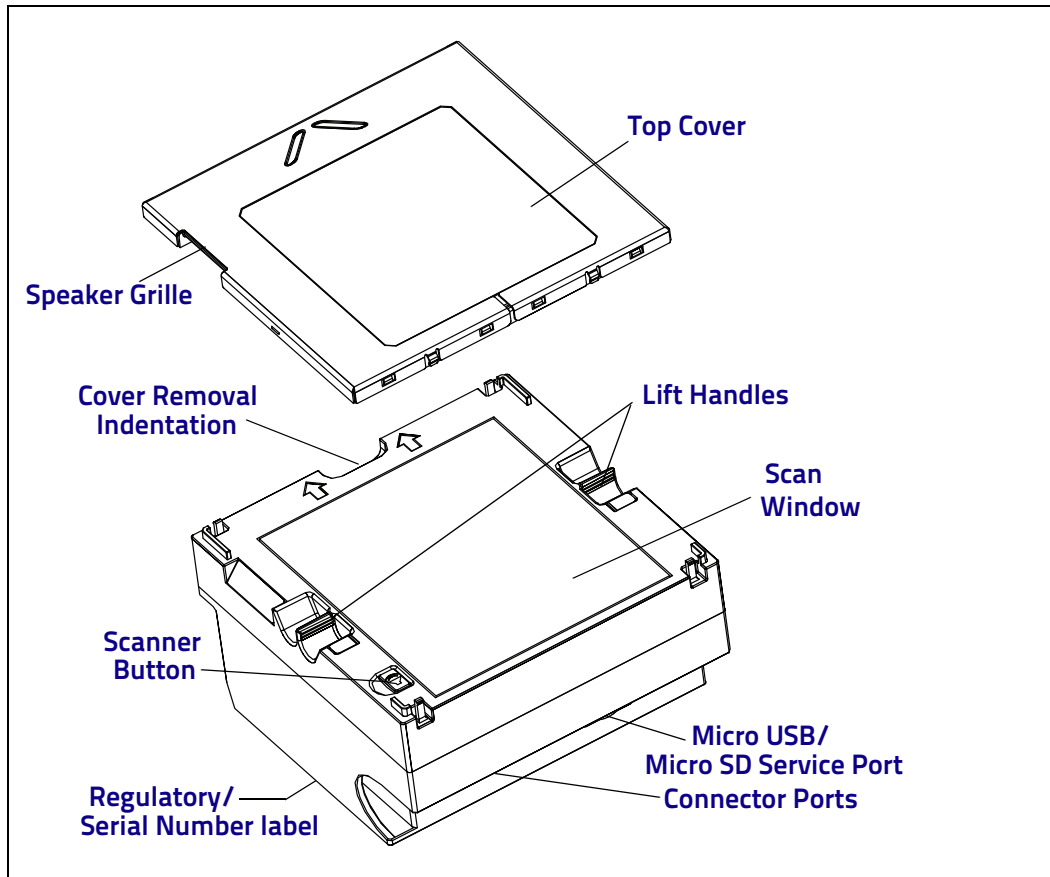
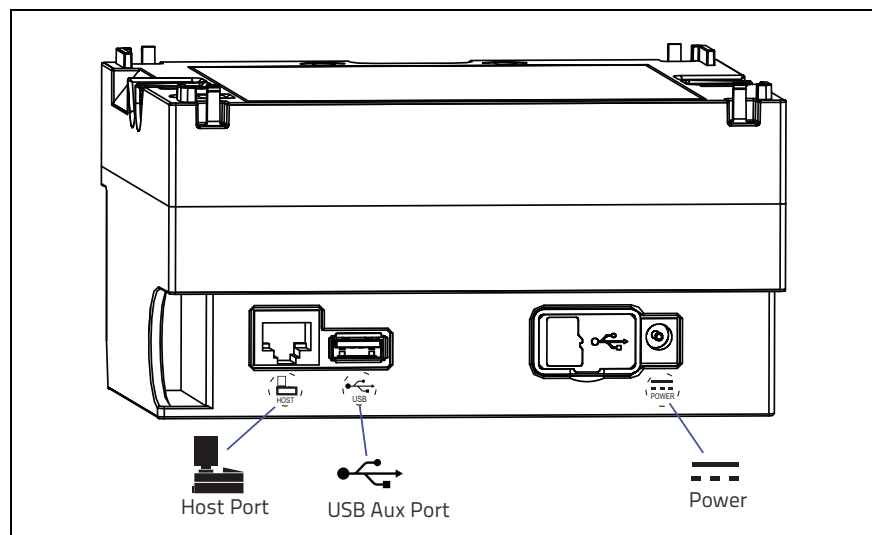

Figure 4. Scanner Features - Bottom View





## Chapter 2 Programming

### Introduction to Label Programming

The programming bar code labels contained in this manual will allow you to customize and configure features and settings for your scanner. To ensure full compatibility and proper function, use only the programming bar codes in this manual and other product-specific publications to program scanner features.

This manual has been developed to make it quick and easy for users of all levels to find the information needed to understand and configure features. The following descriptions will help you to determine where to go from here.

### Understanding the Basics

If you have little or no prior experience with programming using bar code labels, you should review the first few pages of this section to familiarize yourself with the basics of scanner programming before performing any changes to your configuration.

### Using the Programming Bar Codes

The scanner is typically factory-configured with a set of default features standard to the interface type you ordered. After scanning the interface bar code from the [Interface Related Features](#) section, you can select other options and customize your scanner through use of the instructions and programming bar codes available in that section and also the [Data Editing](#) and [1D Symbologies](#) chapters of this manual.

This manual contains feature descriptions and bar codes which allow you to reconfigure your scanner. Some programming bar code labels, like the label below for resetting defaults, require only the scan of that single label to enact the change. Most of the programming labels in this manual, however, require the scanner to be placed in Programming Mode prior to scanning them. Scan a Enter/Exit Programming Mode bar code once to enter Programming Mode. Once the scanner is in Programming Mode, you can scan a number of parameter settings before scanning the Enter/Exit Programming Mode bar code a second time, which will then accept your changes, exit Programming Mode, reset the scanner and return it to normal operation.

## Resetting the Standard Product Defaults

If you are unsure of what programming options are in your scanner, or you've changed some options and want the factory settings restored, scan the *Standard Product Default Settings* bar code below. This will copy the factory configuration for the currently active interface to the current configuration.

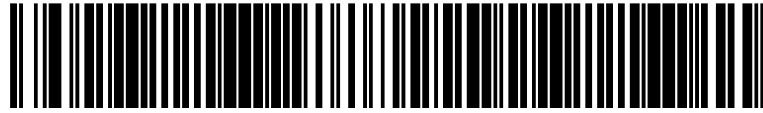

Standard Product Default Settings

The programming section lists the factory default settings for each of the menu commands for the standard RS-232 interface, indicated by a green arrow. Exceptions to default settings for the other interfaces can be found in [Appendix D, Factory Default Settings](#).



## Using a Bar Code Mask

The programming bar codes in this manual have been placed as multiples per page. In order to present them only one at a time to the scanner, a bar code mask is provided on the opposite side of this page.

## Going Green

Thank you for using the bar code mask on the opposite side of this page. This manual has been formatted to minimize the quantity of pages needed to provide all of the programming bar codes available for this product.



## Bar Code Mask

Cut a hole in this page and remove it from the manual as indicated to create a sleeve through which bar codes (starting in the following section) can be individually viewed and scanned. It is important that only one bar code at a time be presented to the scanner.

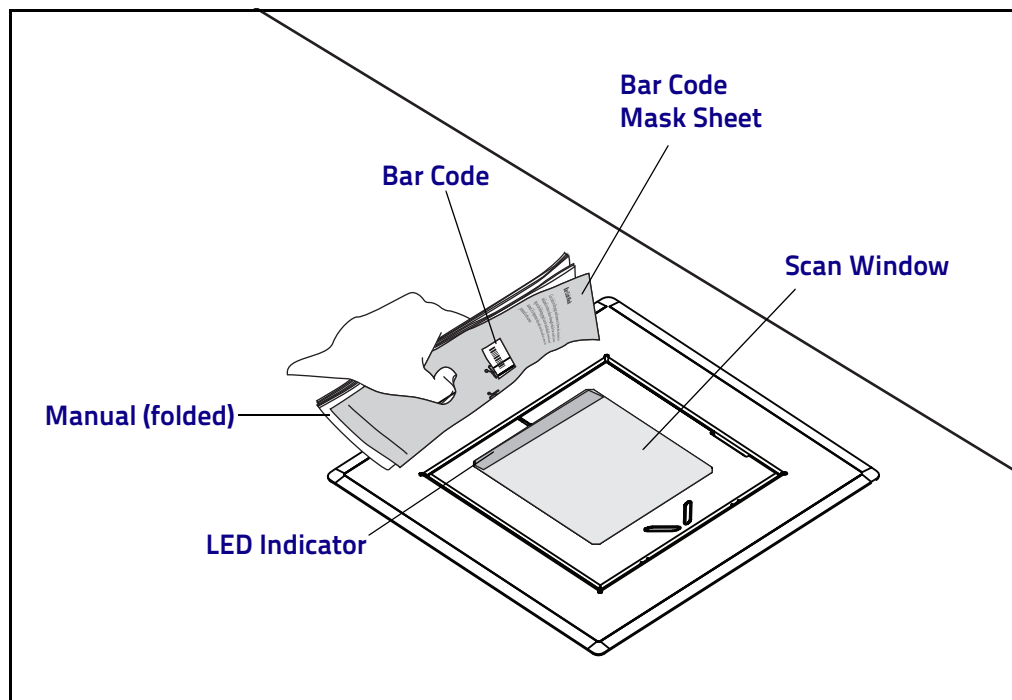



# General Scanner Features

## **SCANNING FEATURES** starting on page 10

- 1D Double Read Timeout on page 10
- 2D Double Read Timeout on page 11
- Digital Watermark (Digimarc®) Features on page 12
  - Digital Watermark (Digimarc) Enable on page 12
  - Digital Watermark (Digimarc) Double Read Timeout on page 13
  - Digital Watermark (Digimarc) Data Format on page 14
- Sleep Mode Timer on page 15
- 1D Inverse Read Control on page 16
- 2D Inverse Read Control on page 17
- Reading Illumination Duration on page 18

## **LED AND BEEPER INDICATORS** starting on page 19

- Power On Alert on page 19
- Illumination During Disable Mode on page 20
- Object Sense Control on page 21
- Exposure Control on page 22
- External Read Indicator (ERI) on page 23
- ERI Timeout on page 24
- Good Read LED Idle State on page 25
- Scanner Control Button Options on page 26
- Good Read Beep Control on page 27
- Good Read Beep Frequency on page 28
- Good Read Beep Length on page 29
- Good Read Beep Volume on page 30
- Good Read When to Indicate on page 31

## **HOST DOWNLOAD TO HANDHELD** starting on page 32

- Handheld Host Download Timeout on page 32



## SCANNING FEATURES

### 1D Double Read Timeout

The 1D Double Read Timeout feature specifies the minimum allowable time which must pass before reading the same 1D label again (e.g. two identical items in succession).

To set the Double Read Timeout:

1. Scan the Enter/Exit Programming Mode bar code.
2. Scan your selection from the bar codes below. You'll need to cover any unused bar codes on this and the facing page to ensure that the scanner reads only the bar code you intend to scan.
3. Complete the programming sequence by scanning the Enter/Exit Programming Mode bar code.



**NOTE**

**If the incidence of multiple reads is not acceptable, increase the Double Read Timeout setting to a higher value.**



1D Double Read Timeout = 300ms



1D Double Read Timeout = 400ms



1D Double Read Timeout = 600ms



1D Double Read Timeout = 800ms

## 2D Double Read Timeout

The 2D Double Read Timeout feature specifies the minimum allowable time which must pass before reading the same 2D label again (e.g. two identical items in succession).

To set this feature:

1. Scan the Enter/Exit Programming Mode bar code.
2. Scan your selection from the bar codes below. You'll need to cover any unused bar codes on this and the facing page to ensure that the scanner reads only the bar code you intend to scan.
3. Complete the programming sequence by scanning the Enter/Exit Programming Mode bar code.



### NOTE

If the incidence of multiple reads is not acceptable, increase the Timeout setting to a higher value.



2D Double Read Timeout = 300ms



2D Double Read Timeout = 400ms



2D Double Read Timeout = 600ms

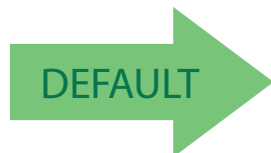

2D Double Read Timeout = 700ms



2D Double Read Timeout = 800ms

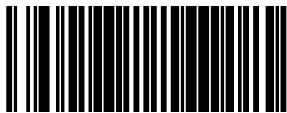

## Digital Watermark (Digimarc®) Features



NOTE

The Digital Watermark feature must be enabled for decode functionality.

### Digital Watermark (Digimarc) Enable

Enables/Disables the ability of the scanner to decode Digimarc Digital Watermarks.

To set this feature:

1. Scan the Enter/Exit Programming Mode bar code.
2. Scan your selection from the bar codes below. You'll need to cover any unused bar codes on this and the facing page to ensure that the scanner reads only the bar code you intend to scan.
3. Complete the programming sequence by scanning the Enter/Exit Programming Mode bar code.



NOTE

The Digimarc Digital Watermark feature requires the purchase of a special software license to activate it. For more information, please contact your Datalogic representative.



Digital Watermark (Digimarc) = Disable



Digital Watermark (Digimarc) = Enable



## Digital Watermark (Digimarc) Double Read Timeout

Specifies the minimum allowable time which must pass before reading the same Digital Watermark (Digimarc) label again (e.g. two identical items in succession).

To set this feature:

1. Scan the Enter/Exit Programming Mode bar code.
2. Scan your selection from the bar codes below. You'll need to cover any unused bar codes on this and the facing page to ensure that the scanner reads only the bar code you intend to scan.

Complete the programming sequence by scanning the Enter/Exit Programming Mode bar code.



**If the incidence of multiple reads is not acceptable, increase the Double Read Timeout setting to a higher value.**



Digimarc Double Read Timeout = 0.3 Seconds



Digimarc Double Read Timeout = 0.4 Seconds

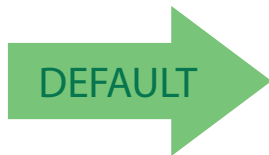

Digimarc Double Read Timeout = 0.5 Seconds



Digimarc Double Read Timeout = 0.7 Seconds



Digimarc Double Read Timeout = 1 Second



## Digital Watermark (Digimarc) Data Format

Selects the format for the watermark data. Choices are:

- Compatibility mode
- Databar-14
- Native

1. Scan the Enter/Exit Programming Mode bar code.
2. Scan your selection from the bar codes below. You'll need to cover any unused bar codes on this and the facing page to ensure that the scanner reads only the bar code you intend to scan.
3. Complete the programming sequence by scanning the Enter/Exit Programming Mode bar code.



**NOTE**

**The Digital Watermark feature must be enabled for decode functionality.**

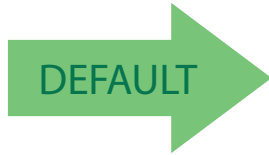

Digital Watermark (Digimarc) Data Format = Compatibility mode



Digital Watermark (Digimarc) Data Format = Databar-14 mode



Digital Watermark (Digimarc) Data Format = Native mode



## Sleep Mode Timer

This feature specifies the amount of time of inactivity (with no label reads) before the scanner enters sleep mode.

To set this feature:

1. Scan the Enter/Exit Programming Mode bar code.
2. Scan the bar code “Set Sleep Mode Timer” below. You’ll need to cover any unused bar codes on this and the facing page to ensure that the scanner reads only the bar code you intend to scan.
3. Scan the appropriate digits from the [Alpha-Numeric Keypad in Appendix C](#) that represent the desired time interval. The selectable range is 000–255 in 15 second increments. Pad all numbers with leading zeros to yield a three-digit entry (000–255).
4. Scan the Enter/Exit Programming Mode bar code to exit Programming Mode.



Set Sleep Mode Timer

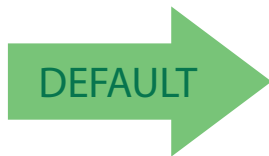

Default setting for this feature is: 5 minutes



## 1D Inverse Read Control

This configuration item is used to toggle inverted label reading for 1D bar codes, for example, a label printed as white on black as opposed to black on white.

To set this feature:

1. Scan the Enter/Exit Programming Mode bar code.
2. Scan your selection from the bar codes below. You'll need to cover any unused bar codes on this and the facing page to ensure that the scanner reads only the bar code you intend to scan.
3. Complete the programming sequence by scanning the Enter/Exit Programming Mode bar code.

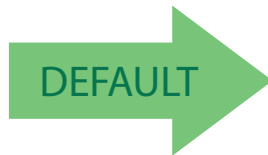

1D Inverse Read Control = Enable



1D Inverse Read Control = Disable

## 2D Inverse Read Control

This configuration item is used to toggle inverted label reading for 2D bar codes, for example, a label printed as white on black as opposed to black on white.

To set this feature:

1. Scan the Enter/Exit Programming Mode bar code.
2. Scan your selection from the bar codes below. You'll need to cover any unused bar codes on this and the facing page to ensure that the scanner reads only the bar code you intend to scan.
3. Complete the programming sequence by scanning the Enter/Exit Programming Mode bar code.

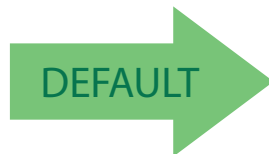

2D Inverse Read Control = Disable



2D Inverse Read Control = Enable



## Reading Illumination Duration

This feature specifies how long the illumination stays on after a label or label segment is read.

To set this feature:

1. Scan the Enter/Exit Programming Mode bar code.
2. Scan your selection from the bar codes below. You'll need to cover any unused bar codes on this and the facing page to ensure that the scanner reads only the bar code you intend to scan.
3. Complete the programming sequence by scanning the Enter/Exit Programming Mode bar code.



Reading Illumination Duration = 1 Seconds



Reading Illumination Duration = 3 Seconds

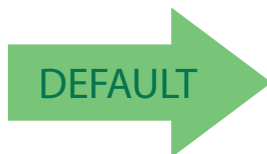

Reading Illumination Duration = 5 Seconds

## LED AND BEEPER INDICATORS

### Power On Alert

Disables or enables the indication that the scanner has finished all its power up tests and is now ready for operation (usually a single beep).



**NOTE**

This feature is configurable so the beep could be replaced with a .wav file.



Power-up Tone Control = No Tone



Power-up Tone Control = Play Tone





## Illumination During Disable Mode

This feature allows illumination to be turned off when the scanner is in “disable” mode. It determines if the imager illumination is controlled by host interface enable/disable commands.

**Disable** = Illumination is not controlled by host enable/disable commands, illumination stays on when disabled.

**Enable** = Illumination is controlled by host enable/disable commands, illumination is on when enabled and off when disabled.

To set this feature:

1. Scan the Enter/Exit Programming Mode bar code.
2. Scan your selection from the bar codes below.
3. Complete the programming sequence by scanning the Enter/Exit Programming Mode bar code.



Illumination During Disable Mode = Disable



Illumination During Disable Mode = Enable



## Object Sense Control

This feature determines whether the main illumination is controlled by the Object Sensing system, or alternatively, stays continuously on.

**Enable** = Illumination is controlled by using Object Sense

**Disable** = Normal illumination is used but it goes off during sleep mode / disable mode

To set this feature:

1. Scan the Enter/Exit Programming Mode bar code.
2. Scan your selection from the bar codes below. You'll need to cover any unused bar codes on this and the facing page to ensure that the scanner reads only the bar code you intend to scan.
3. Complete the programming sequence by scanning the Enter/Exit Programming Mode bar code.

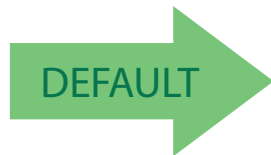

Object Sense Control = Enable



Object Sense Control =Disable



## Exposure Control

This feature controls the depth of field through exposure adjustment. Contact Customer Support for more details about this feature.

To set this feature:

1. Scan the Enter/Exit Programming Mode bar code.
2. Scan your selection from the bar codes below. You'll need to cover any unused bar codes on this and the facing page to ensure that the scanner reads only the bar code you intend to scan.
3. Complete the programming sequence by scanning the Enter/Exit Programming Mode bar code.



Short depth of field



Medium depth of field

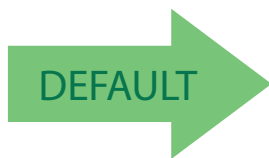

Long depth of field



## External Read Indicator (ERI)



NOTE

This feature is available only through use of a special cable.

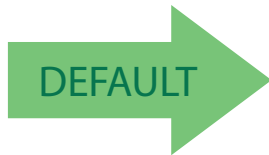

ERI Active State = Active Low



ERI Active State = Active High



## ERI Timeout

Specifies the amount of time the External Read Indicator (ERI) signal is held active for a good read.

To set this feature:

1. Scan the “Enter/Exit Programming Mode” bar code above to place the unit in Programming Mode.
2. Scan the barcode “Set ERI Timeout,” You’ll need to cover any unused bar codes on this and the facing page to ensure that the scanner reads only the bar code you intend to scan.
3. Scan the appropriate digits from the [Alpha-Numeric Keypad in Appendix C](#) that represent the desired time value. The selectable range is 000 to 255 in 10-millisecond increments.
4. Exit programming mode by scanning the “Enter/Exit Programming Mode” bar code again.



Set ERI Timeout

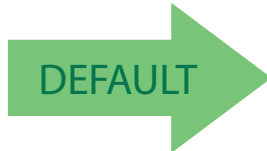

Default setting for this feature is:  
002 -20ms

## Good Read LED Idle State

This feature specifies the state of the green scanner LEDs when the scanner is idle and ready to read a label. Options are:

- Off
- On dim

To set the Scanner LEDs Idle State:

1. Scan the Enter/Exit Programming Mode bar code.
2. Scan your selection from the bar codes below. You'll need to cover any unused bar codes on this and the facing page to ensure that the scanner reads only the bar code you intend to scan.
3. Complete the programming sequence by scanning the Enter/Exit Programming Mode bar code.



Scanner LED Idle State = Off

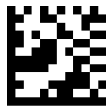

Scanner LED Idle State = On Dim





## Scanner Control Button Options

Configure the Scanner Control Button to one of the following modes of operation:

- Enable all functions: Volume, tone, diagnostics and reset.
- Enable only volume, tone and reset.
- Enable reset only.
- Disable all button functions

To set the desired Scanner Control Button Option:

1. Scan the Enter/Exit Programming Mode bar code.
2. Scan your selection from the bar codes below. You'll need to cover any unused bar codes on this and the facing page to ensure that the scanner reads only the bar code you intend to scan.
3. Complete the programming sequence by scanning the Enter/Exit Programming Mode bar code.



Scanner Control Button = Enable All Functions



Scanner Control Button = Enable Only Volume Tone and Reset



Scanner Control Button = Enable Reset Only



Scanner Control Button = Disable All Functions

## Good Read Beep Control

This feature enables/disables scanner beep upon successfully decoding of a label.

To set this feature:

1. Scan the Enter/Exit Programming Mode bar code.
2. Scan your selection from the bar codes below. You'll need to cover any unused bar codes on this and the facing page to ensure that the scanner reads only the bar code you intend to scan.
3. Complete the programming sequence by scanning the Enter/Exit Programming Mode bar code.



Good Read Beep Control = Disable



Good Read Beep Control = Enable





## Good Read Beep Frequency

Adjusts the scanner's good read beep to sound at low, medium, or high frequency (controls the beeper's pitch/tone).

- Low
- Medium
- High

To set this feature:

1. Scan the Enter/Exit Programming Mode bar code.
2. Scan your selection from the bar codes below. You'll need to cover any unused bar codes on this and the facing page to ensure that the scanner reads only the bar code you intend to scan.
3. Complete the programming sequence by scanning the Enter/Exit Programming Mode bar code.



Good Read Beep Frequency = Low

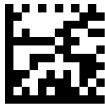

Good Read Beep Frequency = Medium



Good Read Beep Frequency = High

## Good Read Beep Length

Specifies the duration of a good read beep.

To set this feature:

1. Scan the Enter/Exit Programming Mode bar code.
2. Scan the bar code, [Set Good Read Beep Length on page 29](#). You'll need to cover any unused bar codes on this and the facing page to ensure that the scanner reads only the bar code you intend to scan.
3. Scan the appropriate digits from the [Alpha-Numeric Keypad in Appendix C](#) that represent the desired good read beep length setting. The selectable range is 1–255, which is the timeout in 10–millisecond increments. Times have a tolerance of  $\pm 25\%$ . Pad all single and double digit numbers with leading zeroes to yield a three–digit entry (001–255).

Examples:

001 = 10ms

005 = 50ms

040 = 400ms

4. The scanner will automatically exit Programming Mode when the appropriate amount of digits have been scanned.



Set Good Read Beep Length

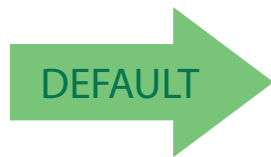

Default setting for this feature is:

008 - 80ms



## Good Read Beep Volume

Selects the beeper volume upon a good read beep. There are five selectable volumes, with each volume increment adding approximately five decibels to the previous level:

- Low
- Medium Low
- Medium
- Medium High
- High

To set this feature:

1. Scan the Enter/Exit Programming Mode bar code.
2. Scan your selection from the bar codes below. You'll need to cover any unused bar codes on this and the facing page to ensure that the scanner reads only the bar code you intend to scan.
3. Complete the programming sequence by scanning the Enter/Exit Programming Mode bar code.



Good Read Beep Volume = Low

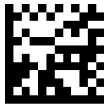

Good Read Beep Volume = Medium Low

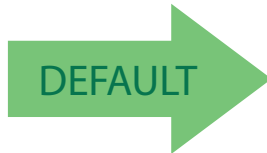

Good Read Beep Volume = Medium



Good Read Beep Volume = Medium High



Good Read Beep Volume = High



## Good Read When to Indicate

This feature specifies when the scanner will provide indication (beep and/or flash its green LEDs) upon successfully reading a bar code.

- Good Read = Indicate after decode.  
For scanner models having intelligent integrated EAS, label transmission (and hence the good read beep) is completed after the EAS logic executes.
- Good Read = Indicate after transmit
- Good Read = Indicate after CTS goes inactive, then active.  
This mode applies to RS-232 STD and RS-232 WN interfaces only. If set in other interfaces, “Indicate after decode” mode will be implemented.
- Good Read = Indicate after each output structure proofed.  
When beeping after each output structure decoded, if there are multiple output structures, there is a delay after the beep has finished. This delay is equal to the [Good Read Beep Length on page 29](#).

To set the Good Read When to Indicate feature:

1. Scan the Enter/Exit Programming Mode bar code.
2. Scan the desired mode bar code from those provided below You’ll need to cover any unused bar codes on facing pages to ensure that the scanner reads only the bar code you intend to scan.
3. Complete the programming sequence by scanning the Enter/Exit Programming Mode bar code.



Good Read When to Indicate = After Decode



Good Read When to Indicate = After Transmit



Good Read When to Indicate = After CTS goes Inactive,  
Then Active



Good Read When to Indicate = After Each Output  
Structure Proofed



## Host Download To Handheld

Attached Datalogic handheld scanners can be updated via the host port. Contact Technical Support for details.

### Handheld Host Download Timeout

This feature sets the timeout (in seconds) to wait for a response from the handheld when performing a host download to the handheld.

To set this feature:

1. Scan the Enter/Exit Programming Mode bar code.
2. Scan the bar code below, Set Handheld HDL Timeout. You'll need to cover any unused bar codes on this and the facing page to ensure that the scanner reads only the bar code you intend to scan.
3. Scan the appropriate digits from the [Alpha-Numeric Keypad in Appendix C](#) that represent the desired delay. The selectable range is 001–255, which is the delay in 1-second increments. Pad all single and double digit numbers with leading zeroes to yield a three-digit entry (001–255).
4. Complete the programming sequence by scanning the Enter/Exit Programming Mode bar code.

Examples:

002 = 2 seconds

005 = 5 seconds

015 = 15 seconds



Set Handheld HDL Timeout

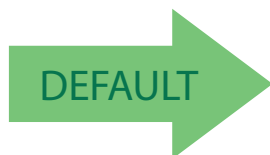

Default setting for this feature is: 15 seconds



## Imaging Features

### **IMAGING FEATURES** starting on page 34

- Image Capture to the Host by Host Command on page 34
- Cell Phone Mode on page 35
- Cell Mode Percent on page 36
- Picture Retrieval Timeout on page 37
- Image Capture Delay on page 39
- Image Format on page 40
- Image Size on page 41
- Image Brightness on page 42
- Image Contrast on page 44
- Image Compression on page 46
- Region of Interest (ROI) on page 47



## Imaging Features

### Image Capture to the Host by Host Command

This feature is only available for RS-232 and USB COM interfaces.

**NOTE**

If the USB COM interface has been selected, follow the instructions in USB-COM Interface Setup on page 51.

The host command format is as follows:

P<cnt>pSBC

where:

**P** – ASCII 'P' used as preamble of pass-through commands

**<cnt>** – binary value of 4 indicating 4 bytes to follow

**p** – ASCII lowercase 'p' ; command to take a picture

**S** – size value of image as ASCII character

'S' == uses scanner's configuration value

'0'–VGA, (640X480)

'1'–WVGA, (752X480)

'2'–SXGA, (1280x1027)

'3'–CIF (320x240)

**B** – brightness value in ASCII

'B' == uses scanner's configuration value CI\_IMAGE\_BRIGHTNESS  
else '0' thru'9' specifies brightness

**C** – contrast value in ASCII

'C' == uses scanner configuration value CI\_IMAGE\_CONTRAST  
else '0' thru'9' specifies contrast

IF the image is of a type the scanner supports, capture and transmission occurs,  
and the command is of proper format

THEN

The scanner will transmit an ACK (0x06) to the Host in response to this command.

The image data transmission starts with a 4 byte binary field representing (Big Endian) number of bytes to follow.

If the “number of bytes to follow” value is zero, there was a problem with generating the image and the request should be retried.

ELSE

The scanner will transmit a BEL (0x07) to the Host in response to this command.

ENDIF

### Cell Phone Mode

Enables/disables the operating mode for mobile phone read.

When cell phone mode is enabled, the scanner stays on regardless of host command or button push. It will not enter sleep mode.



Cell Phone Mode = Enable (Always On)



Cell Phone Mode = Disable





### Cell Mode Percent

Specifies the rate of frames dedicated to reading cell phones. Cell reading feature must be enabled for this to be active. The setting reflects a variable setting (or percentage) of frames dedicated to cell reading.



**As the percentage is increased, object sense (if enabled) will become less responsive. Anything above 10% will have a negative impact on scanning performance.**

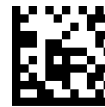
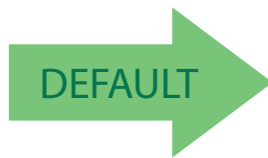

Cell Mode Percent = 2.5% (Very Low)



Cell Mode Percent = 5% (Low)



Cell Mode Percent = 10% (Medium)



Cell Mode Percent = 20% (Medium High)



Cell Mode Percent = 50% (High)

### Picture Retrieval Timeout

This feature sets the amount of time after the picture retrieval label is sent to the POS that the scanner will allow subsequent picture taking requests via button press.



If set to 0, the picture retrieval timeout will not be used and a picture will remain accessible until another is taken or the scanner is reset.



Picture Retrieval Timeout = 0



Picture Retrieval Timeout = 1 second



Picture Retrieval Timeout = 2 seconds



Picture Retrieval Timeout = 3 seconds



Picture Retrieval Timeout = 4 seconds

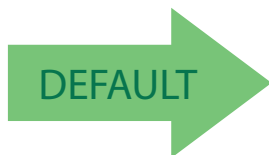

Picture Retrieval Timeout = 5 seconds



**Picture Retrieval Timeout (continued)**



Picture Retrieval Timeout = 6 seconds



Picture Retrieval Timeout = 7 seconds

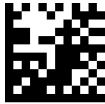

Picture Retrieval Timeout = 8 seconds



Picture Retrieval Timeout = 9 seconds



Picture Retrieval Timeout = 10 seconds



## Image Capture Delay

This feature specifies the amount of time after the image capture is initiated by a button press until the picture is taken.



Image Capture Delay = 0 seconds



Image Capture Delay = 1 second



Image Capture Delay = 2 seconds

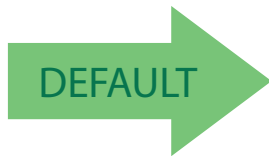

Image Capture Delay = 5 seconds



Image Capture Delay = 10 seconds



## Image Format

This feature specifies the output format for images taken using the camera function of the scanner.

Choices are:

- JPG
- BMP

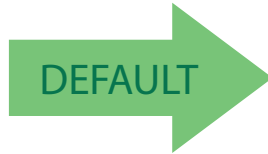

Image Format = JPG



Image Format = BMP

## Image Size

This feature specifies the size of the captured image. Choices are:

**VGA** — Video Graphics Array. 640 x 480 pixels.

**WVGA**. Wide Video Graphics Array, various physical sizes, 16:9 shape

**Full Size**. Maximum image height and width. Largest image.

**Half VGA**. Half of the size of a regular VGA image, 320 x 240 pixels. Smallest image.

**Scaled VGA**. Video Graphics Array, 640 x 480 pixels.

**ROI**. The size of an ROI image is determined by the value of the ROI setting. See "Region of Interest (ROI)" on page 47.

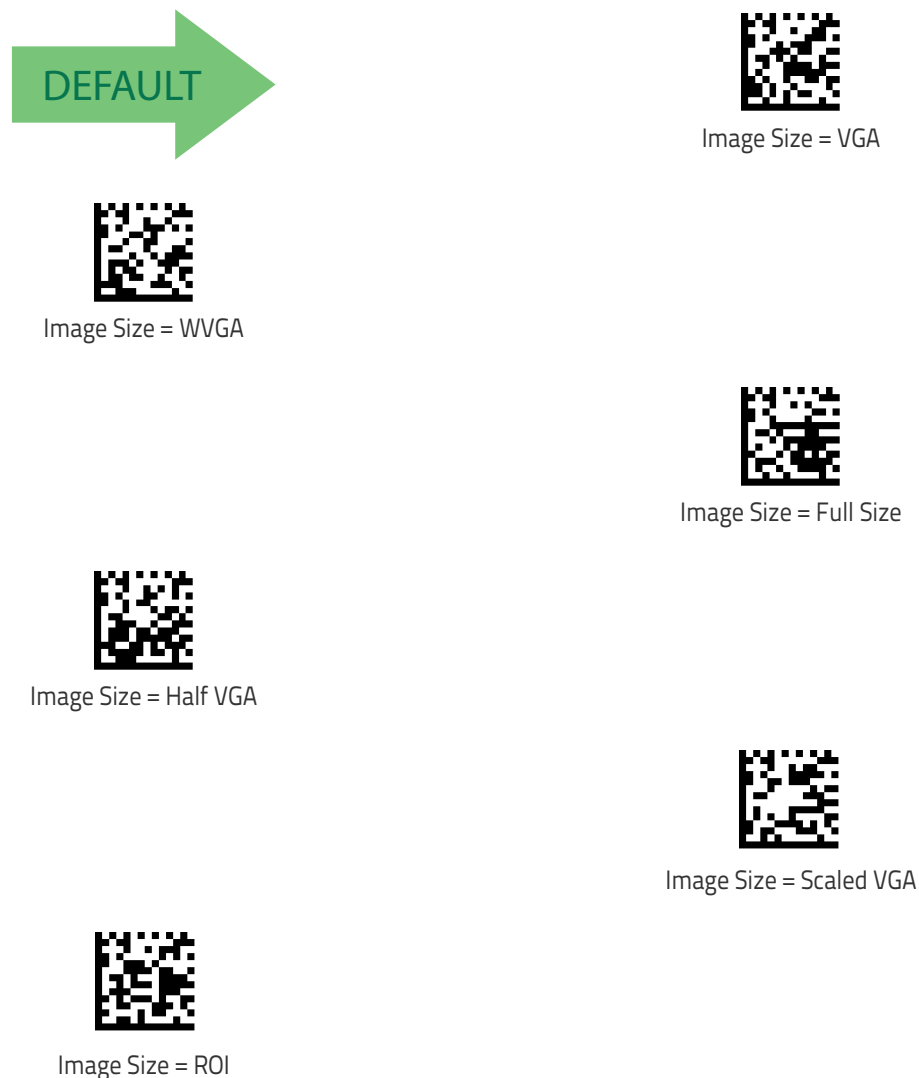



## Image Brightness

Specifies the image brightness value. The selectable range is from 0 to 10, with 10 being the brightest.



Image Brightness = 0



Image Brightness = 1



Image Brightness = 2



Image Brightness = 3



Image Brightness = 4



Image Brightness = 5



Image Brightness = 6



Image Brightness = 7

## Image Brightness (continued)



Image Brightness = 8



Image Brightness = 9



Image Brightness = 10



## Image Contrast

This feature sets the contrast level for a captured image. The selectable range is from 0 to 10, with 0 being the lowest and 10 being the highest contrast.



Image Contrast = 0



Image Contrast = 1



Image Contrast = 2



Image Contrast = 3



Image Contrast = 4



Image Contrast = 5



Image Contrast = 6

## Image Contrast (continued)



Image Contrast = 7



Image Contrast = 8



Image Contrast = 9



Image Contrast = 10



## Image Compression

Specifies the starting image compression factor.



Image Compression = 5



Image Compression = 10



Image Compression = 25



Image Compression = 50



Image Compression = 70



Image Compression = 80



Image Compression = 90

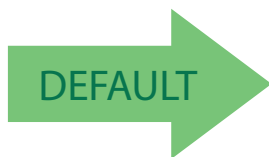
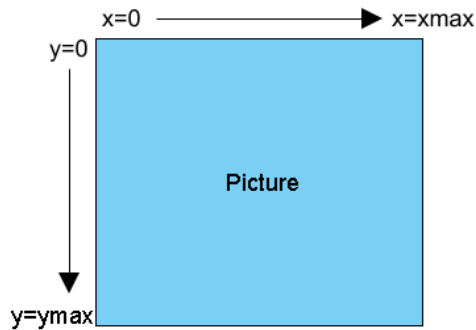

Image Compression = 100



## Region of Interest (ROI)

This feature specifies the X-Y coordinates for the Region of Interest (ROI). The region of interest coordinates are defined as follows:



Where **xmax** is the x-size of a full size image (1279 pixels), and **ymin** is the y-size of a full size image (1023 pixels).

For example, a coordinate set of 0, 639, 512, 1023 will produce the bottom left section of a full size image.



**Picture coordinates are NOT defined on a Cartesian coordinate plane.**

### NOTE

- Byte [0]-[1]: 16 bit hex value xmin
- Byte [2]-[3]: 16 bit hex value xmax
- Byte [4]-[5]: 16 bit hex value ymin
- Byte [6]-[7]: 16 bit hex value ymax



**If the xmax/ymax values are configured larger than the maximum values above, they will default to 1 less than their respective maximum values.**

### NOTES

**If the xmin/ymin values are configured larger than xmax/ymax, they will default to 0.**

**Images extracted with ROI must be in JPG format.**

## Region of Interest (continued)

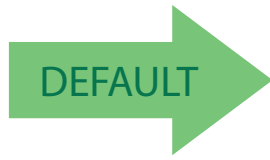

Region of Interest = default



Region of Interest = upper left quadrant



Region of Interest = upper right quadrant



Region of Interest = lower left quadrant



Region of Interest = lower right quadrant



## Interface Related Features

### **USB-COM INTERFACE SETUP** starting on page 51

- USB-COM Interface Setup on page 51
- RS-232 Interface Selection on page 51
- USB Interface Selection on page 52
- Keyboard Interface Selection on page 53
- Maximum Host-Transmitted Message Length on page 54

### **RS-232 INTERFACE FEATURES** starting on page 55

#### RS-232 Interface Features on page 55

- RS-232 Baud Rate on page 55
- RS-232 Number of Data Bits on page 57
- RS-232 Number of Stop Bits on page 57
- RS-232 Parity on page 58
- RS-232 Hardware Control on page 59
- RS-232 Intercharacter Delay on page 60
- RS-232 Software Flow Control on page 61
- RS-232 Beep on ASCII BEL on page 62
- Beep on Not on File on page 62
- RS-232 ACK NAK Features on page 63
  - ACK NAK Enable on page 63
  - RS-232 ACK Character on page 64
  - RS-232 NAK Character on page 65
  - RS-232 Retry on ACK NAK Timeout on page 66
  - RS-232 ACK NAK Timeout Value on page 67
  - RS-232 ACK NAK Retry Count on page 68
  - RS-232 ACK NAK Error Handling on page 69
- RS-232 Indicate Transmission Failure on page 70
- RS-232 Ignore Host Commands on page 71

### **USB-OEM INTERFACE FEATURES** starting on page 72

- USB OEM Scanner Device Type on page 72

### **USB KEYBOARD FEATURES** starting on page 74

- Keyboard Layout on page 74
- USB Keyboard Country Mode on page 74
- USB Keyboard Caps Lock State on page 77
- No Keyboard Support on page 78
- USB Keyboard Send Control Characters on page 79
- Quiet Interval on page 80
- USB Keyboard Intercharacter Delay on page 81
- USB Keyboard Additional Interface Options on page 82

## INTERFACE SELECTION

### Interface Type

Specifies the current scanner interface. To access a scanner's interface identification number, place the scanner in Scanner Diagnostic Mode and view the 7-segment FRU display (reference Chapter 2, Scale Diagnostic Mode, for more information).



#### NOTE

The correct interface cable is generally included for the reader interface type you ordered.

Selections are:

INTERFACE (I/F) TYPE	I/F I.D. NUMBER
RS-232 Standard	05
RS-232 Wincor-Nixdorf	12
USB OEM	45
USB Keyboard	35
USB-TEC	0D
USB COM	47



#### NOTE

If the scanner's interface type must be changed, always be sure that interface configuration is the **FIRST** item scanned during a programming session. (Selecting an interface type resets **ALL** other configuration items to the factory default for that interface type.)



#### CAUTION

Great care should be taken to select the correct interface type, since you can cause damage to the scanner and/or POS terminal by attempting to change to an incompatible interface. **ALWAYS** make interface selections with the host cable **DISCONNECTED**.



#### NOTE

When an interface is selected, the scanner loads the configuration for that interface as the selection is made. Any custom configurations done in the previous interface will not be carried over to the configuration for the new interface.

## USB-COM Interface Setup

Before plugging your scanner into the Host PC, please ensure you have already copied the executable DLS USB-COM driver file to your PC and that the scanner's interface is set to USB COM. The DLS USB-COM driver (for Windows operating systems) is provided by Datalogic or downloaded from the Datalogic website.

1. Execute the DLS USB-COM driver file.
2. When the scanner is first plugged into the PC, Windows will bring up the "Found New Hardware" message.
3. The installation is complete.



### NOTE

Contact your Datalogic Representative for information about USB-COM operation with other major PC operating systems.

## RS-232 Interface Selection

Remember to cover any unused bar codes on this and the facing page to ensure that the scanner reads only the bar code you intend to scan.



### CAUTION

Great care should be taken to select the correct interface type, since you can cause damage to the scanner and/or POS terminal by attempting to change to an incompatible interface. ALWAYS make interface selections with the host cable DISCONNECTED.



Interface Type = RS-232 Standard



Interface Type = RS-232 Wincor-Nixdorf



## USB Interface Selection

Remember to cover any unused bar codes on this and the facing page to ensure that the scanner reads only the bar code you intend to scan.



**CAUTION**

**Great care should be taken to select the correct interface type, since you can cause damage to the scanner and/or POS terminal by attempting to change to an incompatible interface. ALWAYS make interface selections with the host cable DISCONNECTED.**



Interface Type = USB OEM



Interface Type = USB TEC



Interface Type = USB COM

## Keyboard Interface Selection

Remember to cover any unused bar codes on this and the facing page to ensure that the scanner reads only the bar code you intend to scan.



**CAUTION**

**Great care should be taken to select the correct interface type, since you can cause damage to the scanner and/or POS terminal by attempting to change to an incompatible interface. ALWAYS make interface selections with the host cable DISCONNECTED.**



Interface Type = USB Keyboard



## INTERFACE FEATURES

### Maximum Host-Transmitted Message Length

Specifies the maximum number of data characters allowed in messages transmitted to the host.

To set the Maximum Host-Transmitted Message Length:

1. Scan the Enter/Exit Programming Mode bar code.
2. Scan the bar code [Set Maximum Host-Transmitted Message Length](#) below. You'll need to cover any unused bar codes on this and the facing page to ensure that the scanner reads only the bar code you intend to scan.
3. Scan the appropriate digits from the [Keypad on page 461](#) in [Appendix C](#) that represent the desired maximum host-transmitted message length. The selectable range is 0-249 data characters. (Labels that are longer than this length are not read.) Pad all single and double digit numbers with leading zeroes to yield a three-digit entry (000-249).



**If this configuration item is set to 0 (000), there is no general length limit imposed on data being transmitted to the host.**

#### NOTE

4. The scanner will automatically exit Programming Mode when the appropriate amount of digits have been scanned.

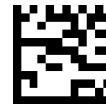

Set Maximum Host-Transmitted Message Length

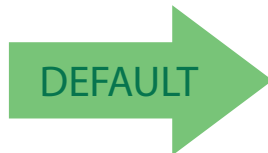

Default setting for this feature is:  
000 - No general limit imposed



## RS-232 Interface Features



NOTE

A setting of no parity with 7 data bits is invalid and will default to 8 data bits and no parity.

### RS-232 Baud Rate



RS-232 Baud Rate = 1200



RS-232 Baud Rate = 2400



RS-232 Baud Rate = 4800



RS-232 Baud Rate = 9600



RS-232 Baud Rate = 19200



RS-232 Baud Rate = 38400



### RS-232 Baud Rate (continued)



RS-232 Baud Rate = 57600



RS-232 Baud Rate = 115200



RS-232 Baud Rate = 230400

## RS-232 Number of Data Bits

Specifies number of data bits required for sending and receiving data..



NOTE

**A setting of 7 data bits with no parity will default to 8 data bits and no parity.**



RS-232 Number of Data Bits = 7



RS-232 Number of Data Bits = 8



## RS-232 Number of Stop Bits

Specifies number of stop bits required for sending and receiving data



RS-232 Number of Stop Bits = 1



RS-232 Number of Stop Bits = 2



## RS-232 Parity

Specifies parity required for sending and receiving data.

Options for this setting are:

- RS-232 PARITY = NONE
- RS-232 PARITY = EVEN
- RS-232 PARITY = ODD.



**NOTE**

**A setting of no parity with 7 data bits will default to 8 data bits and no parity.**

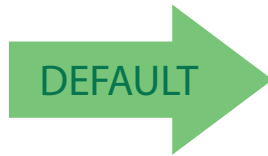

RS-232 Parity = None



RS-232 Parity = Even



RS-232 Parity = Odd

## RS-232 Hardware Control

Enables/disables use of the RS-232 CTS signal for flow control and/or scan control.

Options are:

- **Disable** — The scanner transmits to the host regardless of any activity on the CTS line.
- **Enable CTS Flow Control** — The CTS signal controls transmission of data to the host.
- **Enable CTS Scan Control** — The CTS line must be active for scanner to read and transmit data. While the CTS line is inactive, scanner remains in a host-disabled state; following a successful label transmission, the CTS signal must transition to inactive and then to active to enable scanning for the next label.
- **Enable Magellan SL CTS Scan Control** — Follows the same hardware protocol as older Magellan SL scanners.

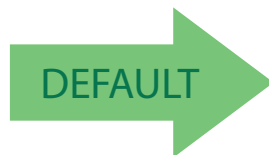

RS-232 Hardware Control = Disable



RS-232 Hardware Control = Enable CTS Flow Control



RS-232 Parity = Enable CTS Scan Control



RS-232 Hardware Control = Enable MGL SL CTS Scan Control



## RS-232 Intercharacter Delay

Specifies delay between the end of one character and the beginning of the next in 10-millisecond increments. This delay is inserted after each data character transmitted. If the transmission speed is too high, the system may not be able to receive all characters. You may need to adjust the delay to make the system work properly.

To set the RS-232 Intercharacter Delay:

1. Scan the Enter/Exit Programming Mode bar code.
2. Scan the bar code below, [Set RS-232 Intercharacter Delay](#).
3. Scan the appropriate digits from the [Alpha-Numeric Keypad in Appendix C](#) that represent the desired delay. The selectable range is 0-100, which is the delay in 10-millisecond increments. Pad all single and double digit numbers with leading zeroes to yield a three-digit entry (000-100).

Examples:

001 = 10ms

005 = 50ms

040 = 400ms

100 = 1,000ms (1 second)

4. The scanner will automatically exit Programming Mode when the appropriate amount of digits have been scanned.



Set RS-232 Intercharacter Delay

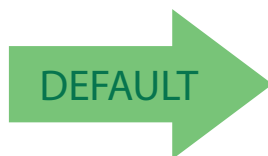

Default setting for this feature is:  
00 - No Intercharacter Delay

## RS-232 Software Flow Control

Enables/disables RS-232 Flow Control using XON/ XOFF characters.



**This item will be ignored when the feature, RS-232 NAK Character, is enabled**

### NOTE

To set this feature:

1. Scan the Enter/Exit Programming Mode bar code.
2. Scan either the enable or disable bar code below. You'll need to cover any unused bar codes on this and the facing page to ensure that the scanner reads only the bar code you intend to scan.
3. Complete the programming sequence by scanning the Enter/Exit Programming Mode bar code.

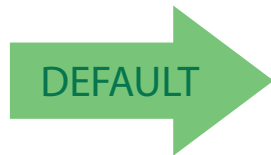

RS-232 Software Flow Control= Disable

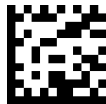

RS-232 Software Flow Control= Enable



## RS-232 Beep on ASCII BEL

Enables/disables ability of scanner to beep (sound a good read tone) on receiving an ASCII BEL (07 hex).

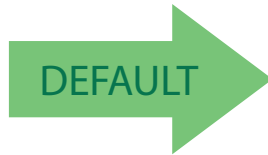

RS-232 Beep on ASCII BEL = Disable



RS-232 Beep on ASCII BEL = Enable

## Beep on Not on File

Select for the host to beep (or not) when a not-on-file condition is detected by the host.



RS-232 Beep on Not on File = Muted



RS-232 Beep on Not on File = Low Volume



RS-232 Beep on Not on File = Medium Volume



RS-232 Beep on Not on File = High Volume



## RS-232 ACK NAK Features

### ACK NAK Enable

This enables/disables the ability of the scanner to support the RS-232 ACK/NAK protocol. When configured, the scanner and/or host sends an “ACK” when it receives data properly, and sends “NAK” when the data is in error. Selections for this option are:

- Disable ACK NAK
- Enable for Label Transmission — the scanner expects an ACK/NAK response from the host when a label is sent)
- Enable for Host Acknowledgement — Enabled for Host Commands (the scanner will respond with ACK/NAK when the host sends a command)
- Enable for Label & Host — Enabled for both Label Transmission & Host Command acknowledgement.

To select the option for RS-232 ACK NAK Enable:

1. Scan the Enter/Exit Programming Mode bar code.
2. Scan the desired option from bar codes below and on the following page. You’ll need to cover any unused bar codes on this and the facing page to ensure that the scanner reads only the bar code you intend to scan.
3. Complete the programming sequence by scanning the Enter/Exit Programming Mode bar code.

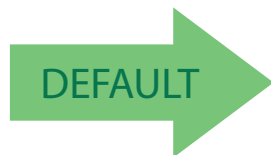

RS-232 ACK NAK = Disable

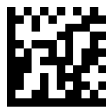

RS-232 ACK NAK = Enable for Label Transmission



RS-232 ACK NAK = Enable for Host Acknowledgment



RS-232 ACK NAK = Enable for Label & Host



### RS-232 ACK Character

This feature specifies which ASCII character will be used as an ACK character.



**NOTE**

**DO NOT set this feature to use previously defined characters such as XON, XOFF or host commands as this will conflict with normal operation of these characters. 8-bit data is not recognized when the feature, RS-232 Number of Data Bits, is set to 7 data bits.**

To specify the RS-232 ACK Character:

1. Scan the Enter/Exit Programming Mode bar code.
2. Scan the bar code, SET RS-232 ACK Character below. You'll need to cover any unused bar codes on this and the facing page to ensure the scanner reads only the bar code you intend to scan.
3. Scan the appropriate digits from the [Alpha-Numeric Keypad in Appendix C](#) that represent the hex designation for the desired character. A table containing the ASCII Character Set and their corresponding Hex Values is available in the inside back cover of this manual. ASCII parameters must be input by scanning a pair of hexadecimal digits for the desired character. For example, if ASCII "A" were the desired ACK character, you would scan the digits "4", then "1" (the ASCII corresponding hex value).
4. The scanner will automatically exit Programming Mode when the appropriate amount of digits/characters have been scanned.



Set RS-232 ACK Character

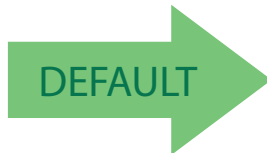

Default setting for this feature is:  
06

## RS-232 NAK Character

This feature specifies which ASCII character will be used as a NAK character.



### NOTE

**DO NOT set this feature to use previously defined characters such as XON, XOFF or host commands as this will conflict with normal operation of these characters. 8-bit data is not recognized when the feature, RS-232 Number of Data Bits, is set to 7 data bits.**

To specify the RS-232 NAK Character:

1. Scan the Enter/Exit Programming Mode bar code.
2. Scan the bar code, SET RS-232 NAK Character below. You'll need to cover any unused bar codes on this and the facing page to ensure the scanner reads only the bar code you intend to scan.
3. Scan the appropriate digits from the [Alpha-Numeric Keypad in Appendix C](#) that represent the hex designation for the desired character. A table containing the ASCII Character Set and their corresponding Hex Values is available in the inside back cover of this manual. ASCII parameters must be input by scanning a pair of hexadecimal digits for the desired character. For example, if ASCII "A" were the desired NAK character, you would scan the digits "4", then "1" (the ASCII corresponding hex value).
4. The scanner will automatically exit Programming Mode when the appropriate amount of digits/characters have been scanned.



Set RS-232 NAK Character

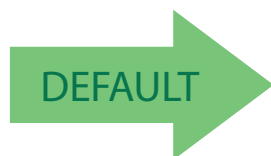

Default setting for this feature is:  
15



### RS-232 Retry on ACK NAK Timeout

This option specifies the action scanner performs on expiration of the RS-232 ACK NAK Timeout Value.



RS-232 Retry on ACK NAK Timeout = Disable



RS-232 Retry on ACK NAK Timeout = Enable



### RS-232 ACK NAK Timeout Value

This item specifies the time the scanner will wait for an ACK character from the host following a label transmission.

- 0 = Infinite timeout
- 1 - 75 = Timeout in 200-millisecond increments

To set the ACK NAK Timeout Value:

1. Scan the Enter/Exit Programming Mode bar code.
2. Scan the bar code below, [Set RS-232 ACK NAK Timeout Value](#). You'll need to cover any unused bar codes on this and the facing page to ensure that the scanner reads only the bar code you intend to scan.
3. Scan the appropriate digits from the [Alpha-Numeric Keypad in Appendix C](#) that represent the desired timeout. A setting of 0 specifies an infinite timeout. The remaining selectable range is 1-75, which is the timeout in 200-millisecond increments. Pad all single digit numbers with a leading zero to yield a two-digit entry (00-75).

Examples:

00 = Infinite timeout

01 = 200ms

05 = 1,000ms (1 second)

40 = 8,000ms (8 seconds)

75 = 15,000ms (15 seconds)

The scanner will automatically exit Programming Mode when the appropriate amount of digits have been scanned.



Set RS-232 ACK NAK Timeout Value

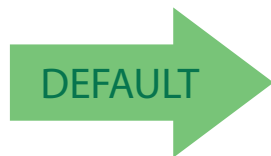

Default setting for this feature is:  
01 - 200ms



### RS-232 ACK NAK Retry Count

This feature sets the number of times for the scanner to retry a label transmission under a retry condition.

To set the RS-232 ACK NAK Retry Count:

1. Scan the Enter/Exit Programming Mode bar code.
2. Scan the bar code, [Set RS-232 ACK NAK Retry Count](#) below. You'll need to cover any unused bar codes on this and the facing page to ensure that the scanner reads only the bar code you intend to scan.
3. Scan the appropriate digits from the [Alpha-Numeric Keypad in Appendix C](#) that represent the desired number. The selectable range is 000-255 resets. Pad all single and double digit numbers with leading zeroes to yield a three-digit entry (000-255).



**A setting of 255 specifies "retry forever."**

**NOTE**

4. The scanner will automatically exit Programming Mode when the appropriate amount of digits have been scanned.



Set RS-232 ACK NAK Retry Count

Default setting for this feature is:  
003 - Three retrys

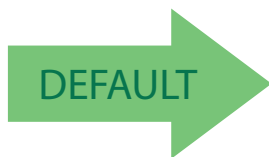

## RS-232 ACK NAK Error Handling

This item specifies the method the scanner will use to handle errors detected while waiting to receive the ACK character from the host. Errors include unrecognized host commands and communication errors such as parity or framing errors.

- Ignore Errors (recommended setting)
- Assume ACK (risk of lost label data)
- Assume NAK (risk of duplicate label)

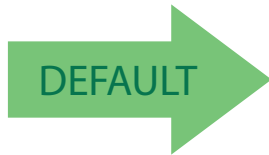

RS-232 ACK NAK Error Handling = Ignore Errors



RS-232 ACK NAK Error Handling = Assume ACK



RS-232 ACK NAK Error Handling = Assume NAK



## RS-232 Indicate Transmission Failure

This feature enables / disables the ability of the scanner to sound a bad label beep indication when a transmission failure occurs.

To set this feature:

1. Scan the Enter/Exit Programming Mode bar code.
2. Scan the desired option from the bar codes below. You'll need to cover any unused bar codes on this and the facing page to ensure that the scanner reads only the bar code you intend to scan.
3. Complete the programming sequence by scanning the Enter/Exit Programming Mode bar code.



RS-232 Indicate Transmission Failure = Disable



RS-232 Indicate Transmission Failure = Enable





## RS-232 Ignore Host Commands

When set to ignore host commands, the scanner will ignore all host commands except the minimum set necessary to keep the interface active and transmit labels. For normal operation of the interface, select Obey Host Commands.

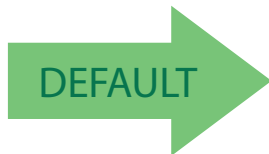

RS-232 Ignore Host Commands = Don't Ignore



RS-232 Ignore Host Commands = Ignore



## USB-OEM Interface Features

### USB OEM Scanner Device Type

The OEM-USB protocol allows for the scanner to be identified as one of two different types of bar code scanners. Depending on what other scanners you may already have connected to a USB POS, you may need to change this setting to enable all scanners to communicate. Options are:

- Table Top Scanner
- Handheld Scanner

To set this feature:

1. Scan the Enter/Exit Programming Mode bar code.
2. Scan your selection from the bar codes below. You'll need to cover any unused bar codes on this and the facing page to ensure that the scanner reads only the bar code you intend to scan.
3. Complete the programming sequence by scanning the Enter/Exit Programming Mode bar code.

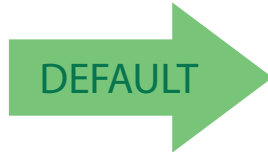

USB OEM Scanner Device Type = Table Top Scanner



USB OEM Scanner Device Type = Handheld Scanner

## USB OEM Additional Interface Options

To set this feature:

1. Scan the Enter/Exit Programming Mode bar code.
2. Scan your selection from the bar codes below. You'll need to cover any unused bar codes on this and the facing page to ensure that the scanner reads only the bar code you intend to scan.
3. Complete the programming sequence by scanning the Enter/Exit Programming Mode bar code.



USB OEM Interfaces Option2 =  
Enable scanner at first enumeration after BusReset



USB OEM Interfaces Option2 =  
Disable scanner at first enumeration after BusReset





## USB Keyboard Features

As a keyboard interface, the scanner supports most popular PC terminals.

### Keyboard Layout

The Keyboard Layout option supports many countries. For details about Keyboard Layout, please refer to your operating system manual.

### USB Keyboard Country Mode

This feature specifies the country/language that will be supported by the keyboard.

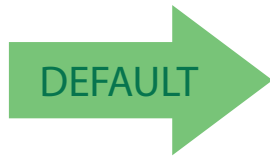

USB Keyboard Country Mode = USA

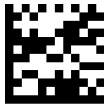

USB Keyboard Country Mode = Belgium



USB Keyboard Country Mode = Britain



USB Keyboard Country Mode = Denmark



USB Keyboard Country Mode = France



USB Keyboard Country Mode = Germany

## USB Keyboard Country Mode (continued)



USB Keyboard Country Mode = Italy



USB Keyboard Country Mode =  
Norway



USB Keyboard Country Mode =  
Portugal



USB Keyboard Country Mode = Spain



USB Keyboard Country Mode =  
Sweden



USB Keyboard Country Mode =  
Switzerland



USB Keyboard Country Mode =  
Japanese 106-key



## USB Keyboard Country Mode (continued)



USB Keyboard Country Mode = Hungary



USB Keyboard Country Mode =  
Czech Republic



USB Keyboard Country Mode = Slovakia

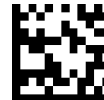

USB Keyboard Country Mode =  
Romania



USB Keyboard Country Mode =  
Croatia



USB Keyboard Country Mode = Poland



USB Keyboard Country Mode =  
French Canadian



USB Keyboard Country Mode = Turkish

## USB Keyboard Caps Lock State

This feature specifies the format in which the scanner sends character data. Selections are:

**Caps Lock OFF** — Send character data in normal format

**Caps Lock ON** — Send character data in reverse case

**Shift Lock Mode** — This setting results in a Caps Lock OFF functionality.

**Caps Lock Compensation Mode** — This only applies to USB Keyboard. For other interfaces, this setting results in a Caps Lock OFF functionality.

To set this feature:

1. Scan the Enter/Exit Programming Mode bar code.
2. Scan the desired selection from the bar codes below. You'll need to cover any unused bar codes on this and the facing page to ensure that the scanner reads only the bar code you intend to scan.
3. Complete the programming sequence by scanning the Enter/Exit Programming Mode bar code.

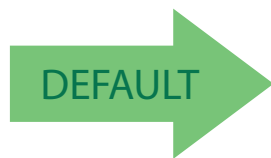

USB Keyboard Caps Lock State =  
Caps Lock OFF



USB Keyboard Caps Lock State =  
Caps Lock ON



USB Keyboard Caps Lock State =  
Shift Lock Mode



USB Keyboard Caps Lock State =  
Caps Lock Compensation



## No Keyboard Support

Enables the scanner to perform host communications normally performed by an attached keyboard.

To set this feature:

1. Scan the Enter/Exit Programming Mode bar code.
2. Scan either the enable or disable bar code below. You'll need to cover any unused bar codes on this and the facing page to ensure that the scanner reads only the bar code you intend to scan.
3. Complete the programming sequence by scanning the Enter/Exit Programming Mode bar code.

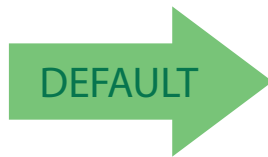

No Keyboard Support = Disable



No Keyboard Support = Enable



## USB Keyboard Send Control Characters

This feature specifies how the scanner transmits ASCII control characters to the host.



**NOTE**

**Affects suffix and prefix characters. When disabled, only ASCII characters between 20H and 127H inclusive (space... delete) plus special characters 0DH (carriage return), 08H (backspace), 27H (ESC), 09H (right tab) and 0BH (left tab) are transmitted.**

Choices are:

**Disable** — No control characters are sent to the host.

**Enable transmission of control characters to host** — Control characters are sent to the host.

**Send characters between 00H and 1FH** — Send characters between 00H and 1FH according to special function–key mapping table (This is used to send keys that are not in normal ASCII set; a unique set is provided for each available scancode set).

To set this feature:

1. Scan the Enter/Exit Programming Mode bar code.
2. Scan the bar code for the desired setting below. You'll need to cover any unused bar codes on this and the facing page to ensure that the scanner reads only the bar code you intend to scan.
3. Complete the programming sequence by scanning the Enter/Exit Programming Mode bar code.

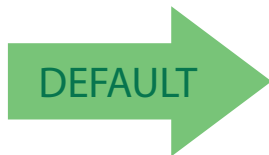

Keyboard Send Control Characters = Disable



Keyboard Send Control Characters =  
Enable transmission of control characters to host



USB Keyboard No Keyboard Support =  
Send characters between 00H and 1FH



## Quiet Interval

This setting specifies the amount of time to monitor for keyboard activity before breaking the keyboard connection.

To set this feature:

1. Scan the Enter/Exit Programming Mode bar code.
2. Scan the bar code below, [Set Quiet Interval](#). You'll need to cover any unused bar codes on this and the facing page to ensure that the scanner reads only the bar code you intend to scan.
3. Scan the appropriate digits from the [Alpha-Numeric Keypad in Appendix C](#) that represent the desired time interval. The selectable range is 001–100, which is the interval in 10–millisecond increments. Pad all single and double digit numbers with leading zeroes to yield a three–digit entry (001–100).

Examples:

001 = 10ms

005 = 50ms

040 = 400ms

100 = 1,000ms (1 second)

4. The scanner will automatically exit Programming Mode when the appropriate amount of digits have been scanned.



Set Quiet Interval

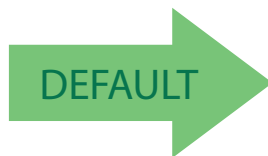

Default setting for this feature is:  
00A - 100ms

## USB Keyboard Intercharacter Delay

Specifies a time delay between characters.

To set this feature:

1. Scan the Set USB Keyboard Intercharacter Delay bar code below.
2. Scan the appropriate characters/digits from the [Alpha-Numeric Keypad in Appendix C](#) that represent the desired delay. The selectable range for this option is any decimal value from 00 (no delay) to 99 in 10 ms increments. A table containing the ASCII Character Set and their corresponding decimal values is available in the inside back cover of this manual. ASCII parameters must be input by scanning decimal digits for each character. Pad all single digit numbers with leading zero to yield a two-digit entry (00–99). Thus, to set an intercharacter delay of 70ms, bar codes containing the digits '0' and '7' must be scanned.
3. Complete the programming sequence by scanning the Enter/Exit Programming Mode bar code.



Set USB Keyboard Intercharacter Delay

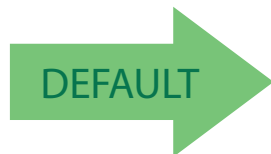

Default setting for this feature is: 01 (10ms)



## USB Keyboard Additional Interface Options

To set this feature:

1. Scan the Enter/Exit Programming Mode bar code.
2. Scan your selection from the bar codes below. You'll need to cover any unused bar codes on this and the facing page to ensure that the scanner reads only the bar code you intend to scan.
3. Complete the programming sequence by scanning the Enter/Exit Programming Mode bar code.



USB Keyboard Interface Option 1 =  
Use Rev C function table



USB Keyboard Interfaces Option 2 =  
Use Rev D function table





## Data Editing

<b>DATA EDITING OVERVIEW</b> starting on page 84
<b>GLOBAL PREFIX/SUFFIX</b> starting on page 85 <ul style="list-style-type: none"><li>•Global Prefix on page 85</li><li>•Global Suffix on page 86</li></ul>
<b>AIM ID</b> starting on page 87
<b>LABEL ID</b> starting on page 88 <ul style="list-style-type: none"><li>•Label ID Control on page 88</li><li>•Setting Label ID on page 89</li><li>•1D Symbologies on page 90</li><li>•2D Symbologies on page 95</li></ul>
<b>CASE CONVERSION</b> starting on page 97
<b>CHARACTER CONVERSION</b> starting on page 98



## Data Editing Overview

When a bar code is scanned, additional information can be sent to the host computer along with the bar code data. This combination of bar code data and supplementary user-defined data is called a “message string.” The features in this chapter can be used to build specific user-defined data into a message string.

There are several types of selectable data characters that can be sent before and after scanned data. You can specify if they should be sent with all symbologies, or only with specific symbologies. [Figure 5](#) shows the available elements you can add to a message string:

**Figure 5. Breakdown of a Message String**

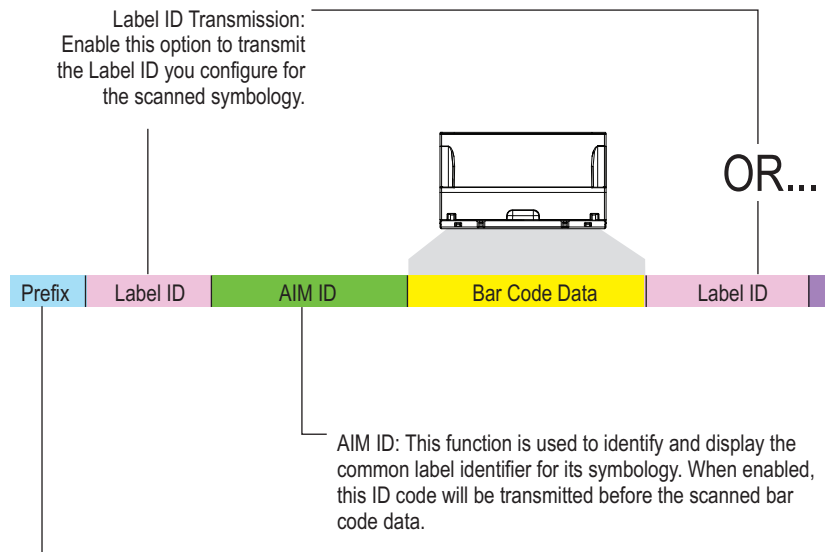

### Please Keep In Mind...

- Modifying a message string is not a mandatory requirement. Data editing is a sophisticated feature allowing highly customizable output for advanced users. Factory default settings for data editing is typically set to NONE.
- A prefix or suffix may be applied (reference the [1D Symbologies](#) chapter for these settings) or across all symbologies (set via the Global features in this chapter).
- You can add any character from the [ASCII Character Set](#) (from 00–FF) on the inside back cover of this manual as a prefix, suffix or Label ID.
- Enter prefixes and suffixes in the order in which you want them to appear on the output.

## Global Prefix/Suffix

### Global Prefix

This feature applies to RS-232 interfaces (Standard, Wincor-Nixdorf). It specifies the prefix that is added to beginning of label transmission.

To specify the Global Prefix Character(s):

1. Scan the Enter/Exit Programming Mode bar code.
2. Scan the bar code Set Global Prefix below. Cover any unused bar codes to ensure the scanner reads only the bar code you intend to scan.
3. Scan the appropriate characters/digits from the [Alpha-Numeric Keypad on page 276](#) that represent the hex designation for the desired character(s). The ASCII Character Set and their corresponding Hex Values are available in the inside back cover of this manual. ASCII parameters must be input by scanning a pair of hexadecimal digits for each character. Thus, to set a two-character value of AB, bar codes containing the digits '4', '1', '4', and '2' must be scanned. The selectable range for this option is any hex value from 00 to FF. Up to 20 hex pairs can be designated.



To specify "No Global Prefix," scan 00.

#### NOTE

4. If designating the full 20 hex pairs, the scanner will exit Programming Mode when the appropriate amount of digits have been scanned. If designating less than 20 hex pairs, you can end the programming sequence early by scanning the Terminate Sequence bar code.
5. Complete the programming sequence by scanning the Enter/Exit Programming Mode bar code.



Set Global Prefix



Terminate Sequence

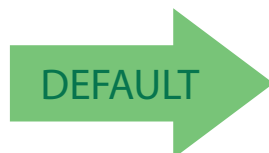

Default setting for this feature is:  
00 - No Global Prefix



## Global Suffix

This feature applies to RS-232 interfaces (Standard, Wincor-Nixdorf). It specifies the suffix that is added to end of a label transmission. Three standard options are available below. Contact your dealer for other alternate settings for this feature.

- No Global Suffix
- CR — Carriage Return
- CR LF — Carriage Return, Line Feed

To set the Global Suffix:

1. Scan the Enter/Exit Programming Mode bar code.
2. Scan your selection from the bar codes below.
3. Complete the programming sequence by scanning the Enter/Exit Programming Mode bar code.



Global Suffix = No Global Suffix



Global Suffix = CR



Global Suffix = CR LF



## AIM ID

AIM (Automatic Identification Manufacturers) label identifiers are assigned from a globally standardized list — as opposed to custom label ID characters you select yourself — and can be included with scanned bar code data. AIM label identifiers consist of three characters as follows:

- A close brace character (ASCII ‘}’), followed by...
- A code character (see the table below), followed by...
- A modifier character (the modifier character is symbol dependent)

SYMBOLLOGY	CHAR	SYMBOLLOGY	CHAR
UPC/EAN	E	Code 128/EAN 128	C
Code 39	A	GS1 Omnidirectional, GS1 Expanded	e
Codabar	F	Standard 2 of 5	S
Interleaved 2 of 5	I	ISBN	X <sup>a</sup>
Code 93	G		

a. ISBN (X with a 0 modifier character)

**Figure 6. AIM ID**

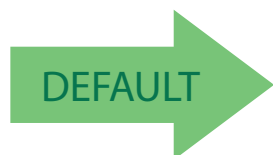
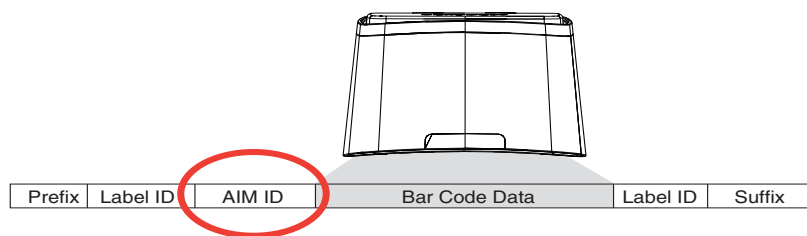

Global AIM ID = Disable



Global AIM ID = Enable



## Label ID

### Label ID Control

This feature specifies whether or not Label IDs are transmitted to the host and if so, whether to attach them as a prefix or suffix.

Choices are:

- Disable
- Enable as a Prefix
- Enable as a Suffix

To select the option for Label ID Control:

1. Scan the Enter/Exit Programming Mode bar code.
2. Scan the desired option from the bar codes below. You'll need to cover any unused bar codes on this and the facing page to ensure that the scanner reads only the bar code you intend to scan.
3. Complete the programming sequence by scanning the Enter/Exit Programming Mode bar code.



Label ID Control = Disable



Label ID Control = Enable as a Prefix



DEFAULT



Label ID Control = Enable as a Suffix

## Setting Label ID

This feature allows the setting of custom Label ID character(s) for each available symbology type if other than the default Label ID is desired.

To set this feature:

1. Scan the Enter/Exit Programming Mode bar code.
2. Scan the bar code for the desired symbology below. You'll need to cover any unused bar codes on this and the facing page to ensure the scanner reads only the bar code you intend to scan.
3. Scan the appropriate digits from the [Alpha-Numeric Keypad on page 276](#) that represent the desired Label ID characters; entered as two hex pairs. A table containing the ASCII Character Set and their corresponding Hex Values is available in the inside back cover of this manual. ASCII parameters must be input by scanning a pair of hexadecimal digits for each character. Thus, to set a two-character value of AB, bar codes containing the digits '4', '1', '4', and '2' must be scanned. The selectable range for this option is any hex value from 00 to FF.

Complete the programming sequence by scanning the Enter/Exit Programming Mode bar code.



## 1D Symbolologies

<p>Default Label ID for this symbology is: 41 = A</p>	 Set UPC-A Label ID
 Set UPC-A 2-Digit Supplemental Label ID	<p>Default Label ID for this symbology is: 41 = A</p>
<p>Default Label ID for this symbology is: 41 = A</p>	 Set UPC-A 5-Digit Supplemental Label ID
 Set UPC-E Label ID	<p>Default Label ID for this symbology is: 45 = E</p>
<p>Default Label ID for this symbology is: 45 = E</p>	 Set UPC-E 2-Digit Supplemental Label ID
 Set UPC-E 5-Digit Supplemental Label ID	<p>Default Label ID for this symbology is: 45 = E</p>
<p>Default Label ID for this symbology is: 46 = F</p>	 Set EAN-13 Label ID

## Setting Label ID (continued)







 Set EAN-13 2-Digit Supplemental Label ID	Default Label ID for this symbology is: 46 = F
Default Label ID for this symbology is: 46 = F	 Set EAN-13 5-Digit Supplemental Label ID
 Set EAN-8 Label ID	Default Label ID for this symbology is: 4646 = FF
Default Label ID for this symbology is: 4646 = FF	 Set EAN-8 2-Digit Supplemental Label ID
 Set EAN-8 5-Digit Supplemental Label ID	Default Label ID for this symbology is: 4646 = FF



### Setting Label ID (continued)

<p>Default Label ID for this symbology is: 47 = G</p>	 <p>Set GTIN Label ID</p>
 <p>Set GTIN 2-Digit Supplemental Label ID</p>	<p>Default Label ID for this symbology is: 4732 = G2</p>
<p>Default Label ID for this symbology is: 4735 = G5</p>	 <p>Set GTIN 5-Digit Supplemental Label ID</p>
 <p>Set GTIN Code 128 Supplemental Label ID</p>	<p>Default Label ID for this symbology is: 4738 = G8</p>
<p>Default Label ID for this symbology is: 5234 = R4</p>	 <p>Set DataBar Omnidirectional Label ID</p>
 <p>Set DataBar Omnidirectional Composite Label ID</p>	<p>Default Label ID for this symbology is: 5234 = R4</p>
<p>Default Label ID for this symbology is: 5258 = RX</p>	 <p>Set DataBar Limited Label ID</p>

## Setting Label ID (continued)

Default Label ID for this symbology is: 5258 = RX	 DataBar Expanded Label ID
 DataBar Expanded Composite Label ID	Default Label ID for this symbology is: 5258 = RX
Default Label ID for this symbology is: 5258 = RX	 Set DataBar Limited Composite Label ID
 Code 39 Label ID	Default Label ID for this symbology is: 2A = *
Default Label ID for this symbology is: 41 = A	 Code 32 Label ID
 Code 128 Label ID	Default Label ID for this symbology is: 23 = #
Default Label ID for this symbology is: 50 = P	 EAN 128 Label ID







### Setting Label ID (continued)

<p>Default Label ID for this symbology is: 69 = i</p>	 <p>12 of 5 Label ID</p>
 <p>Codabar Label ID</p>	<p>Default Label ID for this symbology is: 25 = %</p>
<p>Default Label ID for this symbology is: 26 = &amp;</p>	 <p>Code 93 Label ID</p>
 <p>MSI Label ID</p>	<p>Default Label ID for this symbology is: 40 = @</p>
<p>Default Label ID for this symbology is: 73 = s</p>	 <p>Standard 2 of 5 Label ID</p>
 <p>ISBN Label ID</p>	<p>Default Label ID for this symbology is: 49 = l</p>



## 2D Symbologies

Default Label ID for this symbology is: 446D = Dm	 Data Matrix Label ID
 PDF 417 Label ID	Default Label ID for this symbology is: 50 = P
Default Label ID for this symbology is: 6D50 = mP	 Micro PDF 417 Label ID
 QR Code Label ID	Default Label ID for this symbology is: 5152 = QR
Default Label ID for this symbology is: 2451 = \$Q	 Micro QR Code Label ID
 Aztec Label ID	Default Label ID for this symbology is: 417A = Az
Default Label ID for this symbology is: 4467 = Dg	 GS1 Datamatrix label ID
 GS1 QR Code label ID	Default Label ID for this symbology is: 5147 = QG



## Global Mid-Label ID

This feature specifies a global mid-label ID that is added between two bar codes for transmission.

To set this feature:

1. Scan the Enter/Exit Programming Mode bar code.
2. Scan the [Set Global Mid-Label ID on page 96](#) bar code below. You'll need to cover any unused bar codes on this and the facing page to ensure the scanner reads only the bar code you intend to scan.
3. Scan the appropriate digits from the [Keypad on page 461](#) in [Appendix C](#) that represent the desired mid-label ID characters; entered as two hex pairs. A table containing the ASCII Character Set and their corresponding Hex Values is available in the inside back cover of this manual. ASCII parameters must be input by scanning a pair of hexadecimal digits for each character. Thus, to set a two-character value of AB, bar codes containing the digits '4', '1', '4', and '2' must be scanned. The selectable range for this option is any hex value from 00 to FF.

Complete the programming sequence by scanning the Enter/Exit Programming Mode bar code.



Set Global Mid-Label ID

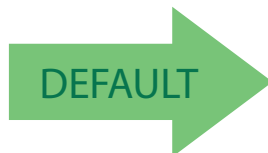

Default Label ID for this symbology is:  
00 = No Global Mid-label ID

## Case Conversion

This option can change the case of all alphabetic characters in scanned bar code data to upper or lower case.



### NOTE

**Case conversion affects ONLY scanned bar code data, and does not affect Label ID, Prefix, Suffix, or other appended data.**

To set this feature:

1. Scan the Enter/Exit Programming Mode bar code.
2. Scan bar code for the desired option below. You'll need to cover any unused bar codes on this and the facing page to ensure that the scanner reads only the bar code you intend to scan.
3. Complete the programming sequence by scanning the Enter/Exit Programming Mode bar code.

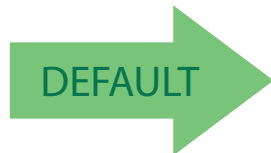

Case Conversion = No Case Conversion



Case Conversion = Upper Case



Case Conversion = Lower Case



## Character Conversion

Character conversion is an eight byte configuration item. The eight bytes are 4 character pairs represented in hexadecimal ASCII values. The first character in the pair is the character that will be converted. The second character in the pair is the character to convert to. If the character to convert in a pair is FF, then no conversion is done.

For example, if you have the character conversion configuration item set to the following:

41423132FFFFFFF

The first pair is 4142 or AB (41 hex is an ASCII capital A, 42 hex is an ASCII capital B) and the second pair is 3132 or 12 (31 hex is an ASCII 1, 32 is an ASCII 2). The other two pairs are FFFF and FFFF.

With the label, AG15TA81, it would look as follows after the character conversion: BG25TB82.

The A characters were converted to the B character and the 1 characters were converted to the numeral 2 character. Nothing is done with the last two character pairs, since they are all FF.

To set Character Conversion:

1. Scan the Enter/Exit Programming Mode bar code.
2. Scan the Character Conversion bar code.
3. Determine the desired string. Up to sixteen positions can be determined as in the above example. Next, turn to the ASCII Chart on the inside back cover of this manual and find the equivalent hex digits needed to fulfill the string.



**The positions not used must be filled with the character 'F'.**

**NOTE**

4. Turn to the [Alpha-Numeric Keypad on page 276](#) and scan the bar codes representing the hex characters determined in the previous step. When the last character is scanned, the scanner will sound a triple beep.
5. Complete the programming sequence by scanning the Enter/Exit Programming Mode bar code.



Set Character Conversion

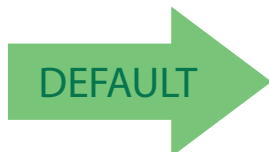

Default setting for this feature is:  
FFFFFFFFFFFFFFFF (No Character Conversion)



# 1D Symbology Programming

## 1D Symbologies



### NOTE

If the scanner's interface type must be changed, always be sure that interface configuration is the **FIRST** item scanned during a programming session. (Selecting an interface type resets **ALL** other configuration items — including symbology programming — to the factory default for that interface type.)

The following pages contain configuration information concerning the various bar code types (symbologies) the scanner supports.

<b>COUPON CONTROL</b> starting on page 100
<b>UPC-A</b> starting on page 102
<b>UPC-E</b> starting on page 107
<b>EAN-13</b> starting on page 113
<b>EAN-8</b> starting on page 118
<b>OTHER UPC/EAN OPTIONS</b> starting on page 130
<b>GTIN</b> starting on page 150
<b>GS1 DATABAR</b> starting on page 151
<b>DATABAR OMNIDIRECTIONAL</b> starting on page 151
<b>DATABAR LIMITED</b> starting on page 156
<b>DATABAR EXPANDED</b> starting on page 160
<b>CODE 39</b> starting on page 168
<b>CODE 32 ITALIAN PHARMACODE</b> starting on page 180
<b>CODE 128</b> starting on page 183
<b>EAN-128</b> starting on page 192
<b>INTERLEAVED 2 OF 5 (I 2 OF 5)</b> starting on page 193
<b>CODABAR</b> starting on page 202
<b>CODE 93</b> starting on page 215
<b>MSI</b> starting on page 222
<b>STANDARD 2 OF 5</b> starting on page 232



# Coupon Control

## Coupon Control Enable

This feature is used to control the method of processing coupon labels. For the purposes of this feature, coupon labels are defined as:

1. UPC-A labels that start with a '5'
2. GS1 DataBar Expanded labels that start with '8110'

The options for this setting are:

- Disable — Coupon Control is turned off.
- Enable UPC-A Coupons — UPC-A coupon labels will decode but GS1 DataBar Expanded coupon labels will not. GS1 DataBar Expanded labels that are not coupon labels will decode and all UPC-A labels will decode.
- Enable GS1 DataBar Expanded Coupons — GS1 DataBar Expanded coupon labels will decode but UPC-A coupon labels will not. UPC-A labels that are not coupon labels will decode and all GS1 DataBar Expanded labels will decode.

To set this feature:

1. Scan the Enter/Exit Programming Mode bar code.
2. Scan your choice from the Coupon Control selections below. You'll need to cover any unused bar codes on this and the facing page to ensure that the scanner reads only the bar code you intend to scan.
3. Complete the programming sequence by scanning the Enter/Exit Programming Mode bar code.



Coupon Control = Disable



Coupon Control = Enable UPC-A Coupons



Coupon Control = Enable GS1 DataBar Expanded Coupons

## Coupon Label Priority Timer

This feature sets the duration of the UPCA / DataBar coupon label priority timer.  
To set this feature:

1. Scan the Enter/Exit Programming Mode bar code.
2. Scan your selection from the bar codes below. You'll need to cover any unused bar codes on this and the facing page to ensure that the scanner reads only the bar code you intend to scan.
3. Complete the programming sequence by scanning the Enter/Exit Programming Mode bar code.



Coupon Label Priority Timer = 0.1 Seconds



Coupon Label Priority Timer = 0.2 Seconds



Coupon Label Priority Timer = 0.3 Seconds



Coupon Label Priority Timer = 0.4 Seconds



Coupon Label Priority Timer = 0.5 Second



Coupon Label Priority Timer = 1 Second



## UPC-A

### UPC-A Enable

Enables/disables the ability of the scanner to decode UPC-A labels.

To set this feature:

1. Scan the Enter/Exit Programming Mode bar code.
2. Scan either the enable or disable bar code below. You'll need to cover any unused bar codes on this and the facing page to ensure that the scanner reads only the bar code you intend to scan.
3. Complete the programming sequence by scanning the Enter/Exit Programming Mode bar code.



UPC-A = Disable



UPC-A = Enable





## UPC-A Number System Character Transmission

Enables/disables transmission of a UPC-A number system character.



**This item is ignored when the advanced feature, Full Label Edit, is enabled.**

### NOTE

To set this feature:

1. Scan the Enter/Exit Programming Mode bar code.
2. Scan either the enable or disable bar code below. You'll need to cover any unused bar codes on this and the facing page to ensure that the scanner reads only the bar code you intend to scan.
3. Complete the programming sequence by scanning the Enter/Exit Programming Mode bar code.



UPC-A Number System Character Transmission =  
Disable



UPC-A Number System Character Transmission = Enable



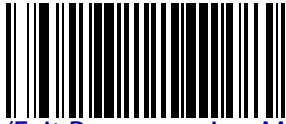

## UPC-A Check Character Transmission

Enables/disables transmission of a UPC-A check character.



**This item is ignored when the advanced feature, Full Label Edit, is enabled.**

### NOTE

To set this feature:

1. Scan the Enter/Exit Programming Mode bar code.
2. Scan either the enable or disable bar code below. You'll need to cover any unused bar codes on this and the facing page to ensure that the scanner reads only the bar code you intend to scan.
3. Complete the programming sequence by scanning the Enter/Exit Programming Mode bar code.



UPC-A Check Character Transmission = Disable



UPC-A Check Character Transmission = Enable



## UPC-A Minimum Read

This feature specifies the minimum number of consecutive UPC-A decodes before is accepted as good read.

To set this feature:

1. Scan the ENTER/EXIT Programming Mode bar code.
2. Scan your selection from the bar codes below. You'll need to cover any unused bar codes on this and the facing page to ensure that the scanner reads only the bar code you intend to scan.
3. Complete the programming sequence by scanning the ENTER/EXIT Programming Mode bar code.

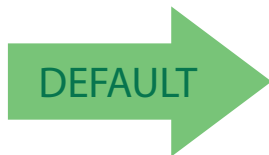

UPC-A Minimum Read = 1



UPC-A Minimum Read = 2



UPC-A Minimum Read = 3



UPC-A Minimum Read = 4

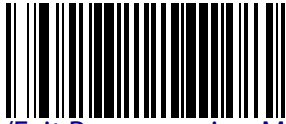

## Expand UPC-A to EAN-13

Enables/disables expansion of UPC-A labels to EAN/JAN-13.

To set this feature:

1. Scan the Enter/Exit Programming Mode bar code.
2. Scan either the enable or disable bar code below. You'll need to cover any unused bar codes on this and the facing page to ensure that the scanner reads only the bar code you intend to scan.
3. Complete the programming sequence by scanning the Enter/Exit Programming Mode bar code.

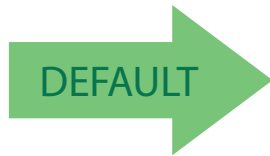

Expand UPC-A to EAN-13 = Disable



Expand UPC-A to EAN-13 = Enable

## UPC-E

### UPC-E Enable

Enables/disables the ability of the scanner to decode UPC-E labels.

To set this feature:

1. Scan the Enter/Exit Programming Mode bar code.
2. Scan either the enable or disable bar code below. You'll need to cover any unused bar codes on this and the facing page to ensure that the scanner reads only the bar code you intend to scan.
3. Complete the programming sequence by scanning the Enter/Exit Programming Mode bar code.



UPC-E = Disable



UPC-E = Enable





## UPC-E Number System Character Transmission

Enables/disables transmission of a UPC-E number system character.



**This item is ignored when the advanced feature, Full Label Edit, is enabled.**

### NOTE

To set this feature:

1. Scan the Enter/Exit Programming Mode bar code.
2. Scan either the enable or disable bar code below. You'll need to cover any unused bar codes on this and the facing page to ensure that the scanner reads only the bar code you intend to scan.
3. Complete the programming sequence by scanning the Enter/Exit Programming Mode bar code.



UPC-E Number System Character Transmission = Disable



UPC-E Number System Character Transmission = Enable



## UPC-E Check Character Transmission

Enables/disables transmission of a UPC-E check character.



**This item is ignored when the advanced feature, Full Label Edit, is enabled.**

### NOTE

To set this feature:

1. Scan the Enter/Exit Programming Mode bar code.
2. Scan either the enable or disable bar code below. You'll need to cover any unused bar codes on this and the facing page to ensure that the scanner reads only the bar code you intend to scan.
3. Complete the programming sequence by scanning the Enter/Exit Programming Mode bar code.



UPC-E Check Character Transmission = Disable



UPC-E Check Character Transmission = Enable



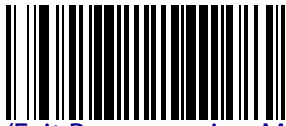

## Expand UPC-E to UPC-A

Enables/disables expansion of UPC-E labels to UPC-A.

To set this feature:

1. Scan the Enter/Exit Programming Mode bar code.
2. Scan either the enable or disable bar code below. You'll need to cover any unused bar codes on this and the facing page to ensure that the scanner reads only the bar code you intend to scan.
3. Complete the programming sequence by scanning the Enter/Exit Programming Mode bar code.

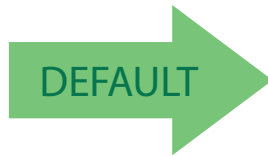

Expand UPC-E to UPC-A = Disable

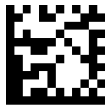

Expand UPC-E to UPC-A = Enable



## Expand UPC-E to EAN-13

Enables/disables expansion of UPC-E labels to EAN/JAN-13.

To set this feature:

1. Scan the Enter/Exit Programming Mode bar code.
2. Scan either the enable or disable bar code below. You'll need to cover any unused bar codes on this and the facing page to ensure that the scanner reads only the bar code you intend to scan.
3. Complete the programming sequence by scanning the Enter/Exit Programming Mode bar code.

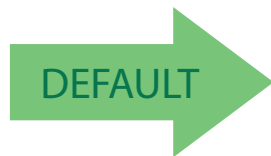

Expand UPC-E to EAN-13 = Disable



Expand UPC-E to EAN-13 = Enable

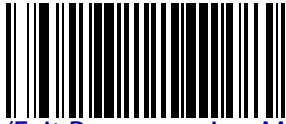

## UPC-E Minimum Read

This feature specifies the minimum number of consecutive UPC-E decodes before is accepted as good read.

To set this feature:

1. Scan the ENTER/EXIT Programming Mode bar code.
2. Scan your selection from the bar codes below. You'll need to cover any unused bar codes on this and the facing page to ensure that the scanner reads only the bar code you intend to scan.
3. Complete the programming sequence by scanning the ENTER/EXIT Programming Mode bar code.

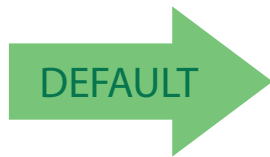

UPC-E Minimum Read = 1



UPC-E Minimum Read = 2



UPC-E Minimum Read = 3



UPC-E Minimum Read = 4

## EAN-13

### EAN-13 Enable

Enables/disables the ability of the scanner to decode EAN/JAN-13 labels.  
To set this feature:

1. Scan the Enter/Exit Programming Mode bar code.
2. Scan either the enable or disable bar code below. You'll need to cover any unused bar codes on this and the facing page to ensure that the scanner reads only the bar code you intend to scan.
3. Complete the programming sequence by scanning the Enter/Exit Programming Mode bar code.



EAN-13 = Disable



EAN-13 = Enable





## EAN-13 First Character Transmission

Enables/disables transmission of EAN/JAN-13 first character.



**This item is ignored when the advanced feature, Full Label Edit, is enabled.**

### NOTE

To set this feature:

1. Scan the Enter/Exit Programming Mode bar code.
2. Scan either the enable or disable bar code below. You'll need to cover any unused bar codes on this and the facing page to ensure that the scanner reads only the bar code you intend to scan.
3. Complete the programming sequence by scanning the Enter/Exit Programming Mode bar code.



EAN-13 First Character Transmission = Disable



EAN-13 First Character Transmission = Enable



## EAN-13 Check Character Transmission

Enables/disables transmission of an EAN/JAN-13 check character.



**This item is ignored when the advanced feature, Full Label Edit, is enabled.**

### NOTE

To set this feature:

1. Scan the Enter/Exit Programming Mode bar code.
2. Scan either the enable or disable bar code below. You'll need to cover any unused bar codes on this and the facing page to ensure that the scanner reads only the bar code you intend to scan.
3. Complete the programming sequence by scanning the Enter/Exit Programming Mode bar code.



EAN-13 Check Character Transmission = Disable



EAN-13 Check Character Transmission = Enable





## EAN-13 ISBN Conversion Enable

Enables/disables conversion of EAN/JAN-13 labels starting with 978 to Bookland ISBN labels.

To set this feature:

1. Scan the Enter/Exit Programming Mode bar code.
2. Scan either the enable or disable bar code below. You'll need to cover any unused bar codes on this and the facing page to ensure that the scanner reads only the bar code you intend to scan.
3. Complete the programming sequence by scanning the Enter/Exit Programming Mode bar code.

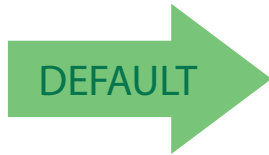

EAN-13 ISBN Conversion = Disable



EAN-13 ISBN Conversion = Enable

## EAN-13 Minimum Read

This feature specifies the minimum number of consecutive EAN-13 decodes before is accepted as good read.

To set this feature:

1. Scan the ENTER/EXIT Programming Mode bar code.
2. Scan your selection from the bar codes below. You'll need to cover any unused bar codes on this and the facing page to ensure that the scanner reads only the bar code you intend to scan.
3. Complete the programming sequence by scanning the ENTER/EXIT Programming Mode bar code.

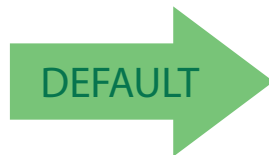

EAN-13 Minimum Read = 1



EAN-13 Minimum Read = 2



EAN-13 Minimum Read = 3



EAN-13 Minimum Read = 4



## EAN-8

### EAN-8 Enable

Enables/disables the ability of the scanner to decode EAN/JAN-8 labels.  
To set this feature:

1. Scan the Enter/Exit Programming Mode bar code.
2. Scan either the enable or disable bar code below. You'll need to cover any unused bar codes on this and the facing page to ensure that the scanner reads only the bar code you intend to scan.
3. Complete the programming sequence by scanning the Enter/Exit Programming Mode bar code.



EAN-8 = Disable



EAN-8 = Enable





## EAN-8 Check Character Transmission

Enables/disables transmission of an EAN/JAN-8 check character.



**This item is ignored when the advanced feature, Full Label Edit, is enabled.**

### NOTE

To set this feature:

1. Scan the Enter/Exit Programming Mode bar code.
2. Scan either the enable or disable bar code below. You'll need to cover any unused bar codes on this and the facing page to ensure that the scanner reads only the bar code you intend to scan.
3. Complete the programming sequence by scanning the Enter/Exit Programming Mode bar code.



EAN-8 Check Character Transmission = Disable



EAN-8 Check Character Transmission = Enable





## Expand EAN-8 to EAN-13

Enables/disables expansion of EAN/JAN-8 labels to EAN/JAN-13.

To set this feature:

1. Scan the Enter/Exit Programming Mode bar code.
2. Scan either the enable or disable bar code below. You'll need to cover any unused bar codes on this and the facing page to ensure that the scanner reads only the bar code you intend to scan.
3. Complete the programming sequence by scanning the Enter/Exit Programming Mode bar code.

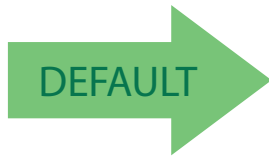

Expand EAN-8 to EAN-13 = Disable



Expand EAN-8 to EAN-13 = Enable

## EAN-8 Minimum Read

This feature specifies the minimum number of consecutive EAN-8 decodes before is accepted as good read.

To set this feature:

1. Scan the ENTER/EXIT Programming Mode bar code.
2. Scan your selection from the bar codes below. You'll need to cover any unused bar codes on this and the facing page to ensure that the scanner reads only the bar code you intend to scan.
3. Complete the programming sequence by scanning the ENTER/EXIT Programming Mode bar code.

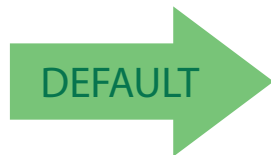

EAN-8 Minimum Read = 1



EAN-8 Minimum Read = 2



EAN-8 Minimum Read = 3



EAN-8 Minimum Read = 4



## EAN-8 Guard Insertion

This setting enables the insertion of either a missing leading or trailing guard to a scanned bar code.

To set this feature:

1. Scan the Enter/Exit Programming Mode bar code.
2. Scan either the enable or disable bar code below. You'll need to cover any unused bar codes on this and the facing page to ensure that the scanner reads only the bar code you intend to scan.
3. Complete the programming sequence by scanning the Enter/Exit Programming Mode bar code.

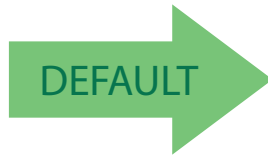

EAN-8 Guard Insertion = Disable



EAN-8 Guard Insertion = Enable

## EAN-8 Guard Substitution

This setting enables the scanner to substitute a guard pattern for even-parity 6 for EAN8/JAN8 labels.

To set this feature:

1. Scan the Enter/Exit Programming Mode bar code.
2. Scan either the enable or disable bar code below. You'll need to cover any unused bar codes on this and the facing page to ensure that the scanner reads only the bar code you intend to scan.
3. Complete the programming sequence by scanning the Enter/Exit Programming Mode bar code.

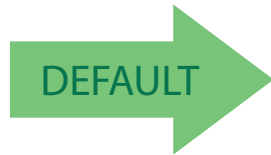

EAN-8 Guard Insertion = Disable



EAN-8 Guard Insertion = Enable



## EAN-8/Jan-8 Both Guards Substitution

Enables/disables the ability of the scanner to find an EAN/JAN8 guard pattern in cases where the EAN/JAN8 margin makes the guard look like a character.

To set this feature:

1. Scan the Enter/Exit Programming Mode bar code.
2. Scan either the enable or disable bar code below. You'll need to cover any unused bar codes on this and the facing page to ensure that the scanner reads only the bar code you intend to scan.
3. Complete the programming sequence by scanning the Enter/Exit Programming Mode bar code.

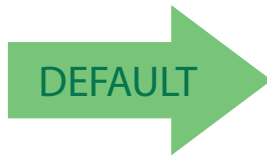

EAN-8/JAN-8 Both Guards Substitution = Disable



EAN-8/JAN-8 Both Guards Substitution = Enable

## EAN-8 Stitch Exact Label Halves

This setting enables the stitching of exact EAN-8 label halves with no overlapping characters.

To set this feature:

1. Scan the Enter/Exit Programming Mode bar code.
2. Scan either the enable or disable bar code below. You'll need to cover any unused bar codes on this and the facing page to ensure that the scanner reads only the bar code you intend to scan.
3. Complete the programming sequence by scanning the Enter/Exit Programming Mode bar code.

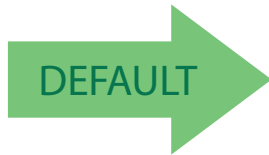

EAN-8 Stitch Exact Label Halves = Disable



EAN-8 Stitch Exact Label Halves = Enable



## EAN-8 Stitch Unlike Label Halves

This setting enables the stitching of two EAN-8 label halves together that may have different characters.

To set this feature:

1. Scan the Enter/Exit Programming Mode bar code.
2. Scan either the enable or disable bar code below. You'll need to cover any unused bar codes on this and the facing page to ensure that the scanner reads only the bar code you intend to scan.
3. Complete the programming sequence by scanning the Enter/Exit Programming Mode bar code.

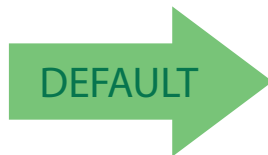

EAN-8 Stitch Unlike Label Halves = Disable



EAN-8 Stitch Unlike Label Halves = Enable



## EAN-8 Minimum Segment Length

Specifies the minimum number of characters necessary in an EAN-8/JAN-8 label segment in order for the scanner to accept a label for decoding. Selectable from 5 to 15 characters. Default setting for this feature is: 08 (8 characters).



EAN-8 Minimum Segment Length = 5 characters



EAN-8 Minimum Segment Length = 6 characters



EAN-8 Minimum Segment Length = 7 characters



EAN-8 Minimum Segment Length = 8 characters



EAN-8 Minimum Segment Length = 9 characters



EAN-8 Minimum Segment Length = 10 characters



EAN-8 Minimum Segment Length = 11 characters



EAN-8 Minimum Segment Length = 12 characters



EAN-8 Minimum Segment Length = 13 characters



EAN-8 Minimum Segment Length = 14 characters



EAN-8 Minimum Segment Length = 15 characters

## EAN-8 Decoding Levels

Decoding levels allow the decoder to be set to perform at one of four selectable levels:

- Very Conservative — Slower scan time, virtually eliminates misreads. The most secure setting.
- Slightly More Aggressive — Faster scanning, more aggressive, yet minimizes misreads.
- Moderately Aggressive — Even faster scanning, even more aggressive.
- Very Aggressive — Fastest scan speed, most aggressive.



Use caution when setting this feature, as more aggressive settings for this feature allow a higher potential for misreads.

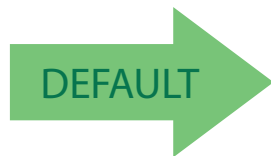

EAN-8 Decoding Level = Very Conservative



EAN-8 Decoding Level = Slightly More Aggressive



EAN-8 Decoding Level = Moderately Aggressive



EAN-8 Decoding Level = Very Aggressive

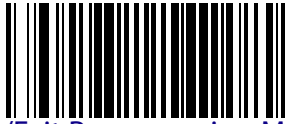

## Other UPC/EAN Options

The following pages contain other selectable features for UPC/EAN symbologies:

▪In-Store Printed Label Minimum Read on page 130	▪UPC/EAN Minimum Segment Length on page 135
▪UPC/EAN Correlation on page 131	▪Price Weight Check on page 137
▪UPC/EAN Guard Insertion on page 132	▪Enable EAN Two Label on page 139
▪UPC/EAN Stitch Exact Label Halves on page 133	▪Add-ons on page 142
▪UPC/EAN Stitch Unlike Label Halves on page 134	

## In-Store Printed Label Minimum Read

This feature specifies the minimum number of consecutive In-Store Printed Label decodes before is accepted as good read. To set this feature:

1. Scan the ENTER/EXIT Programming Mode bar code.
2. Scan your selection from the bar codes below. You'll need to cover any unused bar codes on this and the facing page to ensure that the scanner reads only the bar code you intend to scan.
3. Complete the programming sequence by scanning the ENTER/EXIT Programming Mode bar code.



In-Store Printed Label Minimum Read = 1

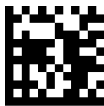

In-Store Printed Label Minimum Read = 2



In-Store Printed Label Minimum Read = 3



In-Store Printed Label Minimum Read = 4

## UPC/EAN Correlation

Enables/disables character correlation for UPC/EAN.

To set this feature:

1. Scan the ENTER/EXIT Programming Mode bar code.
2. Scan either the enable or disable bar code below. You'll need to cover any unused bar codes on this and the facing page to ensure that the scanner reads only the bar code you intend to scan.
3. Complete the programming sequence by scanning the ENTER/EXIT Programming Mode bar code.

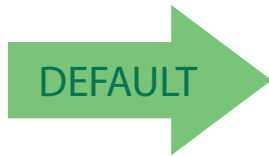

UPC/EAN Correlation = Disable



UPC/EAN Correlation = Enable



## UPC/EAN Guard Insertion

This setting enables the insertion of either a missing leading or trailing guard to a scanned bar code.

To set this feature:

1. Scan the Enter/Exit Programming Mode bar code.
2. Scan either the enable or disable bar code below. You'll need to cover any unused bar codes on this and the facing page to ensure that the scanner reads only the bar code you intend to scan.
3. Complete the programming sequence by scanning the Enter/Exit Programming Mode bar code.

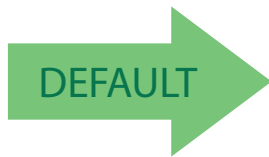

UPC/EAN Guard Insertion = Disable



UPC/EAN Guard Insertion = Enable

## UPC/EAN Stitch Exact Label Halves

This setting enables the stitching of exact UPC-A/EAN-13 label halves with no overlapping characters.

To set this feature:

1. Scan the Enter/Exit Programming Mode bar code.
2. Scan either the enable or disable bar code below. You'll need to cover any unused bar codes on this and the facing page to ensure that the scanner reads only the bar code you intend to scan.
3. Complete the programming sequence by scanning the Enter/Exit Programming Mode bar code.

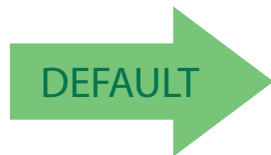

UPC/EAN Stitch Exact Label Halves = Disable



UPC/EAN Stitch Exact Label Halves = Enable

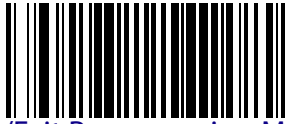

## UPC/EAN Stitch Unlike Label Halves

This setting enables the stitching of two UPC-A/EAN-13 label halves together that may have different characters.

To set this feature:

1. Scan the Enter/Exit Programming Mode bar code.
2. Scan either the enable or disable bar code below. You'll need to cover any unused bar codes on this and the facing page to ensure that the scanner reads only the bar code you intend to scan.
3. Complete the programming sequence by scanning the Enter/Exit Programming Mode bar code.

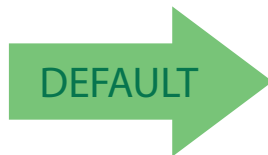

UPC/EAN Stitch Unlike Label Halves = Disable



UPC/EAN Stitch Unlike Label Halves = Enable



## UPC/EAN Minimum Segment Length

This feature specifies the minimum number of characters needed in a UPC/EAN segment in order to be accepted for decoding.

To set this feature:

1. Scan the Enter/Exit Programming Mode bar code.
2. Scan the bar code for the desired setting below. You'll need to cover any unused bar codes on this and the facing page to ensure that the scanner reads only the bar code you intend to scan.
3. Complete the programming sequence by scanning the Enter/Exit Programming Mode bar code.

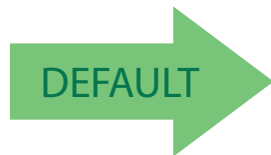

UPC/EAN Minimum Segment Length = 5 Characters



UPC/EAN Minimum Segment Length = 6 Characters



UPC/EAN Minimum Segment Length = 7 Characters



UPC/EAN Minimum Segment Length = 8 Characters



UPC/EAN Minimum Segment Length = 9 Characters



## UPC/EAN Minimum Segment Length (continued)



UPC/EAN Minimum Segment Length = 10 Characters



UPC/EAN Minimum Segment Length = 11 Characters



UPC/EAN Minimum Segment Length = 12 Characters



UPC/EAN Minimum Segment Length = 13 Characters



UPC/EAN Minimum Segment Length = 14 Characters



UPC/EAN Minimum Segment Length = 15 Characters

## Price Weight Check

Enables/disables calculation and verification of price/weight check digits. Applies to all UPC-A and EAN/JAN-13 labels with eligible<sup>1</sup> Number System/First Character digits.

Options are:

- Disable
- 4-digit price/weight
- 5-digit price/weight
- 4-digit European price/weight
- 5-digit European price/weight

To set this feature:

1. Scan the Enter/Exit Programming Mode bar code.
2. Scan the bar code representing the desired option below or on the following pages. You'll need to cover any unused bar codes on facing pages to ensure that the scanner reads only the bar code you intend to scan.
3. Complete the programming sequence by scanning the Enter/Exit Programming Mode bar code.



Price Weight Check = Disable



Price Weight Check = 4-digit price/weight



Price Weight Check = 5-digit price/weight

1. Price Weight Check generally applies to UPC-A labels with a Number System Digit of 2 and EAN/JAN-13 labels with a First Character of 2. There are a total of six flag digits corresponding to the six types. Checking applies depending upon which type is enabled.



## Price Weight Check (continued)



Price Weight Check = 4-digit European price/weight



Price Weight Check = 5-digit European price/weight

## Enable EAN Two Label

Enables/disables the ability of the scanner to decode EAN two-label pairs.  
To set this feature:

1. Scan the Enter/Exit Programming Mode bar code.
2. Scan either the enable or disable bar code below. You'll need to cover any unused bar codes on this and the facing page to ensure that the scanner reads only the bar code you intend to scan.
3. Complete the programming sequence by scanning the Enter/Exit Programming Mode bar code.



### NOTE

Contact Customer Support for details about advanced programming for this feature.

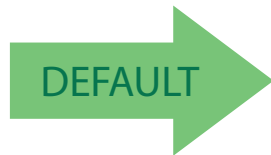

EAN Two Label = Disable



EAN Two Label = Enable

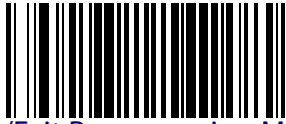

## EAN Two Label Minimum Read

This feature specifies the minimum number of consecutive EAN Two Label decodes before is accepted as good read.

To set this feature:

1. Scan the ENTER/EXIT Programming Mode bar code.
2. Scan your selection from the bar codes below. You'll need to cover any unused bar codes on this and the facing page to ensure that the scanner reads only the bar code you intend to scan.
3. Complete the programming sequence by scanning the ENTER/EXIT Programming Mode bar code.

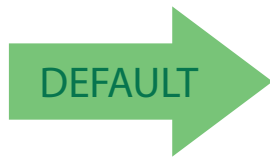

EAN Two Label Minimum Read = 1



EAN Two Label Minimum Read = 2



EAN Two Label Minimum Read = 3



EAN Two Label Minimum Read = 4

## EAN Two Label Combined Transmission

Enables/disables the transmitting of an EAN two label pair as one label.

To set this feature:

1. Scan the Enter/Exit Programming Mode bar code.
2. Scan either the enable or disable bar code below. You'll need to cover any unused bar codes on this and the facing page to ensure that the scanner reads only the bar code you intend to scan.
3. Complete the programming sequence by scanning the Enter/Exit Programming Mode bar code.

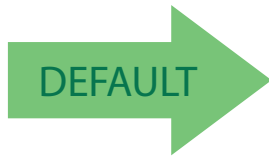

EAN Two Label Combined Transmission = Disable



EAN Two Label Combined Transmission = Enable

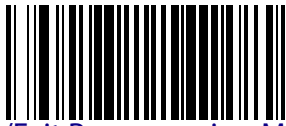

## Add-ons

The scanner is capable of processing different types of add-on codes, including:

- 2-Digit Supplemental
- 5-Digit Supplemental

Options are provided on the following pages for your convenience:

- Disable all add-ons — The scanner will not look for or read add-ons.
- Optional 2-Digit and 5-Digit Supplemental — Bar Codes can be read which include 2-Digit or 5-Digit Supplementals, however, it is not required that add-ons be included in bar codes.



**Contact customer support for advanced programming of optional and conditional add-ons.**

### NOTE

To set this feature:

1. Scan the Enter/Exit Programming Mode bar code.
2. Scan the bar code representing the desired option on this and the following page. You'll need to cover any unused bar codes on facing pages to ensure that the scanner reads only the bar code you intend to scan.
3. Complete the programming sequence by scanning the Enter/Exit Programming Mode bar code.

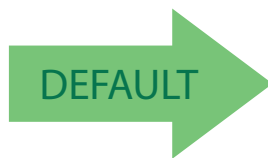

Add-ons = Disable All Add-ons



Add-ons = Optional 2-Digit and 5-Digit Supplemental



## P2 Add-on Minimum Read

This feature specifies the minimum number of times a P2 add-on must decode before it is marked valid.

To set this feature:

1. Scan the Enter/Exit Programming Mode bar code.
2. Scan the bar code representing the desired option on this and the following page. You'll need to cover any unused bar codes on facing pages to ensure that the scanner reads only the bar code you intend to scan.
3. Complete the programming sequence by scanning the Enter/Exit Programming Mode bar code.

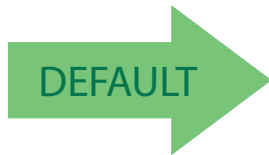

P2 Add-on Minimum Read = 2



P2 Add-on Minimum Read = 3



P2 Add-on Minimum Read = 4



P2 Add-on Minimum Read = 5



P2 Add-on Minimum Read = 6



## P2 Add-on Minimum Read (continued)



P2 Add-on Minimum Read = 7



P2 Add-on Minimum Read = 8



P2 Add-on Minimum Read = 9



P2 Add-on Minimum Read = 10



P2 Add-on Minimum Read = 11



P2 Add-on Minimum Read = 12



P2 Add-on Minimum Read = 13

## P2 Add-on Minimum Read (continued)



P2 Add-on Minimum Read = 14



P2 Add-on Minimum Read = 15

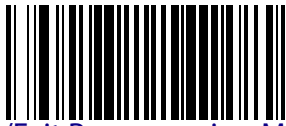

### P5 Add-on Minimum Read

This feature specifies the minimum number of times a P5 add-on must decode before it is marked valid.

To set this feature:

1. Scan the Enter/Exit Programming Mode bar code.
2. Scan the bar code representing the desired option on this and the following page. You'll need to cover any unused bar codes on facing pages to ensure that the scanner reads only the bar code you intend to scan.
3. Complete the programming sequence by scanning the Enter/Exit Programming Mode bar code.



P5 Add-on Minimum Read = 1



P5 Add-on Minimum Read = 2



P5 Add-on Minimum Read = 3



P5 Add-on Minimum Read = 4



P5 Add-on Minimum Read = 5



P5 Add-on Minimum Read = 6

## P5 Add-on Minimum Read (continued)



P5 Add-on Minimum Read = 7



P5 Add-on Minimum Read = 8



P5 Add-on Minimum Read = 9



P5 Add-on Minimum Read = 10



P5 Add-on Minimum Read = 11



P5 Add-on Minimum Read = 12



P5 Add-on Minimum Read = 13



## P5 Add-on Minimum Read (continued)



P5 Add-on Minimum Read = 14



P5 Add-on Minimum Read = 15

## UPC/EAN Composites

Enables/Disables Composites for the UPC/EAN families of labels.

Options are:

To set this feature:

1. Scan the Enter/Exit Programming Mode bar code.
2. Scan the bar code below. You'll need to cover any unused bar codes on this and the facing page to ensure that the scanner reads only the bar code you intend to scan.
3. Scan the appropriate digits from the [Alpha-Numeric Keypad on page 276](#) that represent the desired number. The selectable range is 0–15 resets. Pad all single and double digit numbers with leading zeroes to yield a two-digit entry (00–15).
4. Complete the programming sequence by scanning the Enter/Exit Programming Mode bar code.



SetUPC/EAN Composites

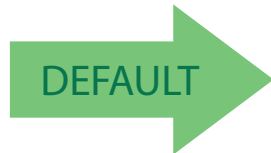

Default setting for this feature is:  
00 - Disabled



## GTIN

### GTIN Enable

Enables/Disables the ability to convert UPCE, UPCA, EAN8, and EAN13 labels into the GTIN 14-character format.



**NOTE**

**If add-on information is present on the base label prior to the conversion taking place, the add-on information will be appended to the converted GTIN bar code.**

To set this feature:

1. Scan the Enter/Exit Programming Mode bar code.
2. Scan either the enable or disable bar code below. You'll need to cover any unused bar codes on this and the facing page to ensure that the scanner reads only the bar code you intend to scan.
3. Complete the programming sequence by scanning the Enter/Exit Programming Mode bar code.

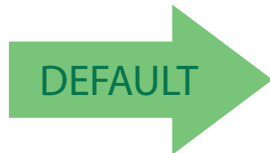

GTIN = Disable



GTIN = Enable



## GS1 DataBar

The symbology family GS1 DataBar™ was formerly known as Reduced Space Symbology (RSS). For the purpose of simplicity, GS1 DataBar variants are listed in this manual as “DataBar.”

## DataBar Omnidirectional

### DataBar Omnidirectional Enable

Enables/disables the ability of the scanner to decode DataBar Omnidirectional labels.



#### NOTE

**This value-added feature is a factory-programmed option. Contact your dealer for information about upgrading your system to include this advanced capability.**

To set this feature:

1. Scan the ENTER/EXIT Programming Mode bar code.
2. Scan either the enable or disable bar code below. You'll need to cover any unused bar codes on this and the facing page to ensure that the scanner reads only the bar code you intend to scan.
3. Complete the programming sequence by scanning the ENTER/EXIT Programming Mode bar code.

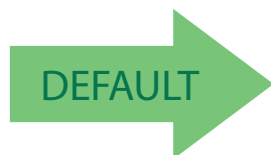

DataBar Omnidirectional = Disable



DataBar Omnidirectional = Enable



## DataBar Omnidirectional/EAN-128 Emulation

Enables/disables the ability of DataBar Omnidirectional to be transmitted as EAN-128.

1. To set this feature:
2. Scan the ENTER/EXIT Programming Mode bar code.
3. Scan either the enable or disable bar code below. You'll need to cover any unused bar codes on this and the facing page to ensure that the scanner reads only the bar code you intend to scan.
4. Complete the programming sequence by scanning the ENTER/EXIT Programming Mode bar code.

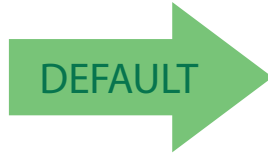

DataBar Omnidirectional/EAN-128 Emulation =  
Disable



DataBar Omnidirectional/EAN-128 Emulation = Enable

## DataBar Omnidirectional 2D Component Enable

When this feature is enabled, the software will not decode an DataBar Omnidirectional bar code with a 2D component associated with it, and the 2D component will be discarded.

To set this feature:

1. Scan the ENTER/EXIT Programming Mode bar code.
2. Scan your selection from the bar codes below. You'll need to cover any unused bar codes on this and the facing page to ensure that the scanner reads only the bar code you intend to scan.
3. Complete the programming sequence by scanning the ENTER/EXIT Programming Mode bar code.

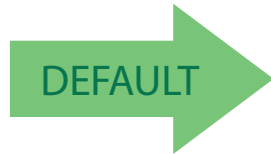

DataBar Omnidirectional 2D Component = Disable



DataBar Omnidirectional 2D Component = Enable



## DataBar Omnidirectional Minimum Read

This feature specifies the minimum number of consecutive DataBar Omnidirectional decodes before is accepted as good read.

To set this feature:

1. Scan the ENTER/EXIT Programming Mode bar code.
2. Scan your selection from the bar codes below. You'll need to cover any unused bar codes on this and the facing page to ensure that the scanner reads only the bar code you intend to scan.
3. Complete the programming sequence by scanning the ENTER/EXIT Programming Mode bar code.

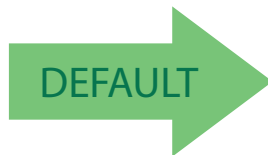

DataBar Omnidirectional Minimum Read = 1



DataBar Omnidirectional Minimum Read = 2



DataBar Omnidirectional Minimum Read = 3



DataBar Omnidirectional Minimum Read = 4

## DataBar Omnidirectional Double Read Timeout

Specifies the minimum allowable time which must pass before reading the same DataBar Omnidirectional label again (e.g. two identical items in succession).

To set this feature:

1. Scan the Enter/Exit Programming Mode bar code.
2. Scan your selection from the bar codes below. You'll need to cover any unused bar codes on this and the facing page to ensure that the scanner reads only the bar code you intend to scan.

Complete the programming sequence by scanning the Enter/Exit Programming Mode bar code.



DataBar Omnidirectional Double Read  
Timeout = 0.5 Seconds



DataBar Omnidirectional Double Read  
Timeout = 1 Second

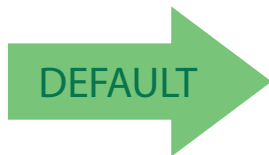

DataBar Omnidirectional Double Read  
Timeout = 2.5 Seconds



DataBar Omnidirectional Double Read  
Timeout = 3 Seconds



DataBar Omnidirectional Double Read  
Timeout = 3.5 Seconds



## DataBar Limited

### DataBar Limited Enable

Enables/disables the ability of the scanner to decode DataBar Limited labels.

To set this feature:

1. Scan the ENTER/EXIT Programming Mode bar code.
2. Scan either the enable or disable bar code below. You'll need to cover any unused bar codes on this and the facing page to ensure that the scanner reads only the bar code you intend to scan.
3. Complete the programming sequence by scanning the ENTER/EXIT Programming Mode bar code.

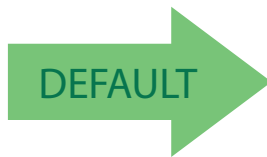

Databar Limited = Disable



Databar Limited = Enable

## DataBar Limited Minimum Read

This feature specifies the minimum number of consecutive Databar Limited decodes before is accepted as good read.

To set this feature:

1. Scan the ENTER/EXIT Programming Mode bar code.
2. Scan either the enable or disable bar code below. You'll need to cover any unused bar codes on this and the facing page to ensure that the scanner reads only the bar code you intend to scan.
3. Complete the programming sequence by scanning the ENTER/EXIT Programming Mode bar code.

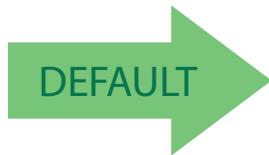

Databar Limited Minimum Read = 1



Databar Limited Minimum Read = 2



Databar Limited Minimum Read = 3



Databar Limited Minimum Read = 4



## DataBar Limited 2D Component Enable

This feature controls if a 2D label component be decoded when a Databar Limited base label is decoded.

To set this feature:

1. Scan the ENTER/EXIT Programming Mode bar code.
2. Scan either the enable or disable bar code below. You'll need to cover any unused bar codes on this and the facing page to ensure that the scanner reads only the bar code you intend to scan.
3. Complete the programming sequence by scanning the ENTER/EXIT Programming Mode bar code.

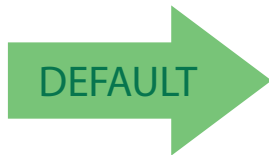

DataBar Limited 2D Component = Disable



DataBar Limited 2D Component = Enable



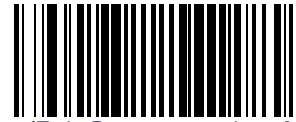

## DataBar Limited EAN128 Emulation Enable

Enables/disables GS1–EAN128 emulation for GS1 Databar Limited.

To set this feature:

1. Scan the ENTER/EXIT Programming Mode bar code.
2. Scan either the enable or disable bar code below. You'll need to cover any unused bar codes on this and the facing page to ensure that the scanner reads only the bar code you intend to scan.
3. Complete the programming sequence by scanning the ENTER/EXIT Programming Mode bar code.

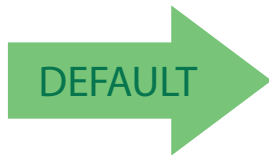

Databar Limited EAN128 Emulation = disable



Databar Limited EAN128 Emulation = enable

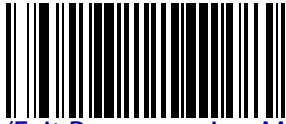

## DataBar Expanded

### DataBar Expanded Enable

Enables/disables the ability of the scanner to decode DataBar Expanded labels.



**NOTE**

**This value-added feature is a factory-programmed option. Contact your dealer for information about upgrading your system to include this advanced capability.**

To set this feature:

1. Scan the ENTER/EXIT Programming Mode bar code.
2. Scan either the enable or disable bar code below. You'll need to cover any unused bar codes on this and the facing page to ensure that the scanner reads only the bar code you intend to scan.
3. Complete the programming sequence by scanning the ENTER/EXIT Programming Mode bar code.

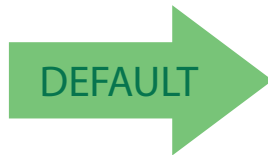

DataBar Expanded = Disable



DataBar Expanded = Enable

## DataBar Expanded EAN-128 Emulation

Enables/disables EAN 128 emulation for DataBar Expanded.

To set this feature:

1. Scan the ENTER/EXIT Programming Mode bar code.
2. Scan either the enable or disable bar code below. You'll need to cover any unused bar codes on this and the facing page to ensure that the scanner reads only the bar code you intend to scan.
3. Complete the programming sequence by scanning the ENTER/EXIT Programming Mode bar code.

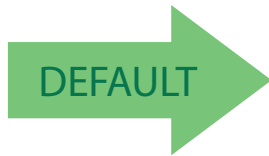

DataBar Expanded EAN-128 Emulation = Disable



DataBar Expanded EAN-128 Emulation = Enable



## DataBar Expanded 2D Component Enable

When this feature is enabled, the software will not decode an DataBar Expanded bar code with a 2D component associated with it, and the 2D component will be discarded.

To set this feature:

1. Scan the ENTER/EXIT Programming Mode bar code.
2. Scan your selection from the bar codes below. You'll need to cover any unused bar codes on this and the facing page to ensure that the scanner reads only the bar code you intend to scan.
3. Complete the programming sequence by scanning the ENTER/EXIT Programming Mode bar code.

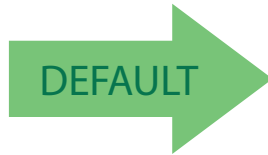

DataBar Expanded 2D Component = Disable



DataBar Expanded 2D Component = Enable

## DataBar Expanded Minimum Read

This feature specifies the minimum number of consecutive DataBar Expanded decodes before is accepted as good read.

To set this feature:

1. Scan the ENTER/EXIT Programming Mode bar code.
2. Scan your selection from the bar codes below. You'll need to cover any unused bar codes on this and the facing page to ensure that the scanner reads only the bar code you intend to scan.
3. Complete the programming sequence by scanning the ENTER/EXIT Programming Mode bar code.

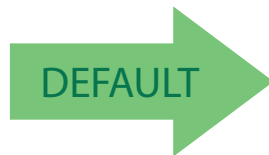

DataBar Expanded Minimum Read = 1



DataBar Expanded Minimum Read = 2



DataBar Expanded Minimum Read = 3



DataBar Expanded Minimum Read = 4



## DataBar Expanded Length Control

This feature specifies either variable-length or fixed-length decoding for DataBar Expanded.

To set this feature:

1. Scan the ENTER/EXIT Programming Mode bar code.
2. Scan your selection from the bar codes below. You'll need to cover any unused bar codes on this and the facing page to ensure that the scanner reads only the bar code you intend to scan.
3. Complete the programming sequence by scanning the ENTER/EXIT Programming Mode bar code.

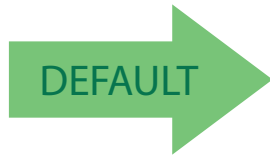

DataBar Expanded Length Control = Variable Length



DataBar Expanded Length Control = Fixed Length

## DataBar Expanded Length 1

Length 1 is the minimum label length if in variable length mode, or the first fixed length if in fixed length mode. Length includes the bar code's data characters only.

To set this feature:

1. Scan the ENTER/EXIT Programming Mode bar code.
2. Scan the bar code, [Set DataBar Expanded Length 1 on page 165](#) below. You'll need to cover any unused bar codes on this and the facing page to ensure that the scanner reads only the bar code you intend to scan.
3. Scan the appropriate digits from the [Alpha-Numeric Keypad in Appendix C](#) that represent the desired label length. The selectable range for this option is 00 to 74. Pad all single digit numbers with a leading zero to yield a two-digit entry (00-74).
4. Complete the programming sequence by scanning the ENTER/EXIT Programming Mode bar code.



Set DataBar Expanded Length 1

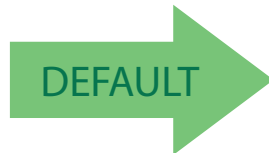

Default setting for this feature = 01

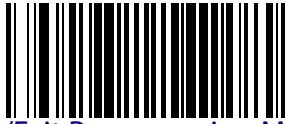

## DataBar Expanded Length 2

Length 2 is the maximum label length if in variable length mode, or the second fixed length if in fixed length mode. Length includes the bar code's data characters only.



**When in Fixed Length mode, if Length 2 is set to the value of 00 (zero), then only Length 1 will apply.**

**NOTE**

To set this feature:

1. Scan the ENTER/EXIT Programming Mode bar code.
2. Scan the bar code, [Set DataBar Expanded Length 2 on page 166](#) below. You'll need to cover any unused bar codes on this and the facing page to ensure that the scanner reads only the bar code you intend to scan.
3. Scan the appropriate digits from the [Alpha-Numeric Keypad in Appendix C](#) that represent the desired label length. The selectable range for this option is 00 to 74. Pad all single digit numbers with a leading zero to yield a two-digit entry (00-74).
4. Complete the programming sequence by scanning the ENTER/EXIT Programming Mode bar code.



Set DataBar Expanded Length 2

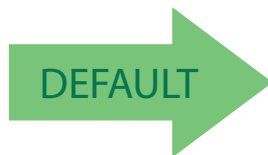

Default setting for this feature = 4A (length = 74)



## DataBar Expanded Reverse Retry

Enables/disables the reading of out of specification labels where the last row has been printed in reverse.

- When enabled, DataBar Expanded Stacked labels that have the last row incorrectly printed in reverse will be re-decoded.
- When disabled, DataBar Expanded Stacked labels that have the last row incorrectly printed in reverse will not be read.

To set this feature:

1. Scan the ENTER/EXIT Programming Mode bar code.
2. Scan your selection from the bar codes below. You'll need to cover any unused bar codes on this and the facing page to ensure that the scanner reads only the bar code you intend to scan.
3. Complete the programming sequence by scanning the ENTER/EXIT Programming Mode bar code.

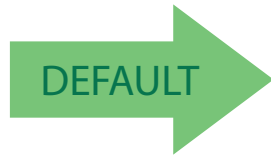

DataBar Expanded Reverse Retry = Disable



DataBar Expanded Reverse Retry = Enable

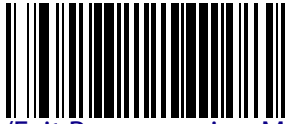

## Code 39

### Code 39 Enable

Enables/disables the ability of the scanner to decode Code 39 labels.

To set this feature:

1. Scan the ENTER/EXIT Programming Mode bar code.
2. Scan either the enable or disable bar code below. You'll need to cover any unused bar codes on this and the facing page to ensure that the scanner reads only the bar code you intend to scan.
3. Complete the programming sequence by scanning the ENTER/EXIT Programming Mode bar code.



Code 39 = Disable



Code 39 = Enable



## Code 39 Start Stop Character Transmission

Enables/disables transmission of Code 39 start and stop characters.



**This item is ignored when the advanced feature, Full Label Edit, is enabled**

### NOTE

To set this feature:

1. Scan the ENTER/EXIT Programming Mode bar code.
2. Scan either the enable or disable bar code below. You'll need to cover any unused bar codes on this and the facing page to ensure that the scanner reads only the bar code you intend to scan.
3. Complete the programming sequence by scanning the ENTER/EXIT Programming Mode bar code.

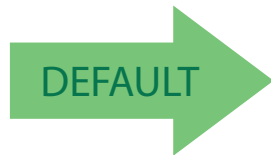

Code 39 Start Stop Character Transmission = Disable



Code 39 Start Stop Character Transmission = Enable

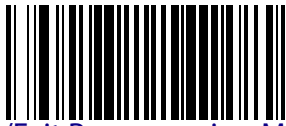

## Code 39 Check Character Calculation

Enables/disables calculation and verification of an optional Code 39 check character. When disabled, any check character in label is treated as a data character.



### NOTE

**If check calculation is disabled, the risk is increased that a misread can occur.**

To set this feature:

1. Scan the ENTER/EXIT Programming Mode bar code.
2. Scan either the enable or disable bar code below. You'll need to cover any unused bar codes on this and the facing page to ensure that the scanner reads only the bar code you intend to scan.
3. Complete the programming sequence by scanning the ENTER/EXIT Programming Mode bar code.

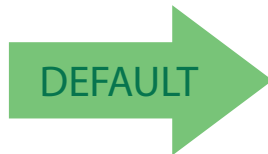

Code 39 Check Character Calculation = Disable



Code 39 Check Character Calculation = Enable

## Code 39 Check Character Transmission

Enables/disables transmission of optional Code 39 check character.



**This item is ignored when the advanced feature, Full Label Edit, is enabled.**

### NOTE

To set this feature:

1. Scan the ENTER/EXIT Programming Mode bar code.
2. Scan either the enable or disable bar code below. You'll need to cover any unused bar codes on this and the facing page to ensure that the scanner reads only the bar code you intend to scan.
3. Complete the programming sequence by scanning the ENTER/EXIT Programming Mode bar code.



Code 39 Check Character Transmission = Disable



Code 39 Check Character Transmission = Enable





## Code 39 Full ASCII

Enables/disables the ability of the scanner to translate to Code 39 full ASCII labels.

To set this feature:

1. Scan the ENTER/EXIT Programming Mode bar code.
2. Scan either the enable or disable bar code below. You'll need to cover any unused bar codes on this and the facing page to ensure that the scanner reads only the bar code you intend to scan.
3. Complete the programming sequence by scanning the ENTER/EXIT Programming Mode bar code.

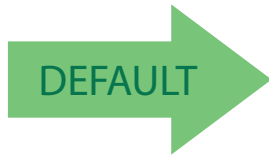

Code 39 Full ASCII = Disable



Code 39 Full ASCII = Enable

## Code 39 Minimum Read

This feature specifies the minimum number of consecutive Code 39 decodes before is accepted as good read.

To set this feature:

1. Scan the ENTER/EXIT Programming Mode bar code.
2. Scan your selection from the bar codes below. You'll need to cover any unused bar codes on this and the facing page to ensure that the scanner reads only the bar code you intend to scan.
3. Complete the programming sequence by scanning the ENTER/EXIT Programming Mode bar code.

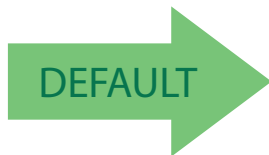

Code 39 Minimum Read = 1



Code 39 Minimum Read = 2



Code 39 Minimum Read = 3



Code 39 Minimum Read = 4

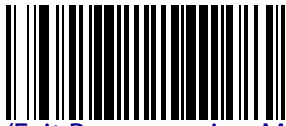

## Code 39 Correlation

Enables/disables character correlation for Code 39.

To set this feature:

1. Scan the ENTER/EXIT Programming Mode bar code.
2. Scan either the enable or disable bar code below. You'll need to cover any unused bar codes on this and the facing page to ensure that the scanner reads only the bar code you intend to scan.
3. Complete the programming sequence by scanning the ENTER/EXIT Programming Mode bar code.

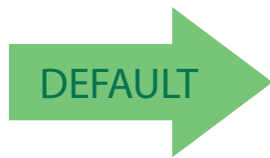

Code 39 Correlation = Disable



Code 39 Correlation = Enable



## Code 39 Length Control

This feature specifies whether variable-length or fixed-length decoding will be set for Code 39.

To set this feature:

1. Scan the ENTER/EXIT Programming Mode bar code.
2. Scan your selection from the bar codes below. You'll need to cover any unused bar codes on this and the facing page to ensure that the scanner reads only the bar code you intend to scan.
3. Complete the programming sequence by scanning the ENTER/EXIT Programming Mode bar code.

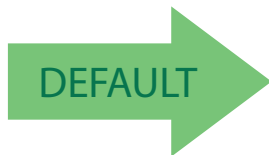

Code 39 Length Control = Variable Length



Code 39 Length Control = Fixed Length



## Code 39 Length 1

If Code 39 Length Control is set to Fixed–Length decoding, this feature specifies Code 39 first fixed length. If Code 39 Length Control is set to Variable–Length decoding, this feature specifies the minimum label length.

To set this feature:

1. Scan the ENTER/EXIT Programming Mode bar code.
2. Scan the bar code, [Set Code 39 Length 1 on page 176](#) below. You’ll need to cover any unused bar codes on this and the facing page to ensure that the scanner reads only the bar code you intend to scan.
3. Scan the appropriate digits from the [Alpha–Numeric Keypad in Appendix C](#) that represent the desired label length. The selectable range for this option is 00 to 50. Pad all single digit numbers with a leading zero to yield a two–digit entry (00–50).
4. Complete the programming sequence by scanning the ENTER/EXIT Programming Mode bar code.



Set Code 39 Length 1

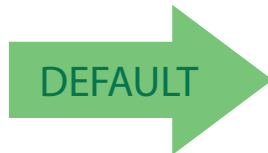

Default setting for this feature = 02

## Code 39 Length 2

If Code 39 Length Control is set to Fixed–Length decoding, this feature specifies Code 39 second fixed length. If Code 39 Length Control is set to Variable–Length decoding, this feature specifies the maximum label length.



### NOTE

**When in Fixed Length mode, if Length 2 is set to the value of 00, then only Length 1 will apply**

To set this feature:

1. Scan the ENTER/EXIT Programming Mode bar code.
2. Scan the bar code, [Set Code 39 Length 2 on page 177](#) below. You'll need to cover any unused bar codes on this and the facing page to ensure that the scanner reads only the bar code you intend to scan.
3. Scan the appropriate digits from the [Alpha–Numeric Keypad in Appendix C](#) that represent the desired label length. The selectable range for this option is 00, no second fixed length, or 01 to 50. Pad all single digit numbers with a leading zero to yield a two–digit entry (00–50).
4. Complete the programming sequence by scanning the ENTER/EXIT Programming Mode bar code.



Set Code 39 Length 2

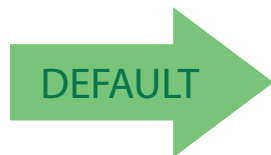

Default setting for this feature = 32 (length = 50)



## Code 39 Stitching

Enables/disables stitching for Code 39 labels. When parts of a Code 39 bar code are presented to the scanner with this feature enabled, the bar code parts will be assembled by the scanner's software, and the data will be decoded if all bar code proofing requirements are met.

To set this feature:

1. Scan the ENTER/EXIT Programming Mode bar code.
2. Scan your selection from the bar codes below. You'll need to cover any unused bar codes on this and the facing page to ensure that the scanner reads only the bar code you intend to scan.
3. Complete the programming sequence by scanning the ENTER/EXIT Programming Mode bar code.



Code 39 Stitching = Disable



Code 39 Stitching = Enable



## Code 39 Require Margins

Enables/disables the requirement that quiet zones be present in a Code 39 bar code.

To set this feature:

1. Scan the ENTER/EXIT Programming Mode bar code.
2. Scan either the enable or disable bar code below. You'll need to cover any unused bar codes on this and the facing page to ensure that the scanner reads only the bar code you intend to scan.
3. Complete the programming sequence by scanning the ENTER/EXIT Programming Mode bar code.

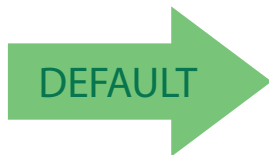

Code 39 Require Margins = Quiet Zones Not Required



Code 39 Require Margins = Quiet Zones Required

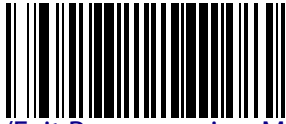

## Code 32 Italian Pharmacode

### Code 32 Italian Pharmacode Enable

Enables/disables the ability of the scanner to decode Italian Pharmaceutical Code 39 labels.

To set this feature:

1. Scan the ENTER/EXIT Programming Mode bar code.
2. Scan either the enable or disable bar code below. You'll need to cover any unused bar codes on this and the facing page to ensure that the scanner reads only the bar code you intend to scan.
3. Complete the programming sequence by scanning the ENTER/EXIT Programming Mode bar code.

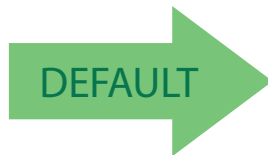

Code 32 Italian Pharmacode Enable = Disable



Code 32 Italian Pharmacode Enable = Enable

## Code 32 Start Stop Character Transmission

Enables/ disables transmission of start and stop characters for Code 32.



**This item is ignored when the advanced feature, Full Label Edit, is enabled.**

### NOTE

To set this feature:

1. Scan the ENTER/EXIT Programming Mode bar code.
2. Scan either the enable or disable bar code below. You'll need to cover any unused bar codes on this and the facing page to ensure that the scanner reads only the bar code you intend to scan.
3. Complete the programming sequence by scanning the ENTER/EXIT Programming Mode bar code.

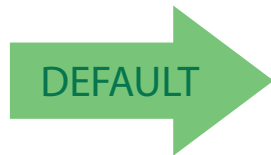

Code 32 Start Stop Character Transmission = Disable



Code 32 Start Stop Character Transmission = Enable



## Code 32 Check Character Transmission

Enables/disables transmission of Code 32 check character.



**This item is ignored when the advanced feature, Full Label Edit, is enabled.**

### NOTE

To set this feature:

1. Scan the ENTER/EXIT Programming Mode bar code.
2. Scan either the enable or disable bar code below. You'll need to cover any unused bar codes on this and the facing page to ensure that the scanner reads only the bar code you intend to scan.
3. Complete the programming sequence by scanning the ENTER/EXIT Programming Mode bar code.

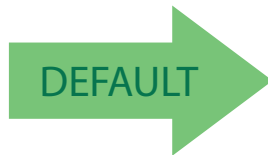

Code 32 Check Character Transmission = Disable



Code 32 Check Character Transmission = Enable



## Code 128

### Code 128 Enable

Enables/disables the ability of the scanner to decode Code 128 labels.  
To set this feature:

1. Scan the ENTER/EXIT Programming Mode bar code.
2. Scan either the enable or disable bar code below. You'll need to cover any unused bar codes on this and the facing page to ensure that the scanner reads only the bar code you intend to scan.
3. Complete the programming sequence by scanning the ENTER/EXIT Programming Mode bar code.



Code 128 = Disable



Code 128 = Enable





## Code 128 Transmit Function Characters

Enables/disables transmission of Code 128 function characters 1, 2, 3, and 4.



**Disabled is the recommended setting for all interfaces.**

### NOTE

To set this feature:

1. Scan the ENTER/EXIT Programming Mode bar code.
2. Scan either the enable or disable bar code below. You'll need to cover any unused bar codes on this and the facing page to ensure that the scanner reads only the bar code you intend to scan.
3. Complete the programming sequence by scanning the ENTER/EXIT Programming Mode bar code.

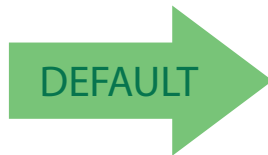

Code 128 Transmit Function Characters = Disable



Code 128 Transmit Function Characters = Enable

## Expand Code128 to Code 39

Enables/disables expansion of Code 128 labels to Code 39.

To set this feature:

1. Scan the ENTER/EXIT Programming Mode bar code.
2. Scan either the enable or disable bar code below. You'll need to cover any unused bar codes on this and the facing page to ensure that the scanner reads only the bar code you intend to scan.
3. Complete the programming sequence by scanning the ENTER/EXIT Programming Mode bar code.

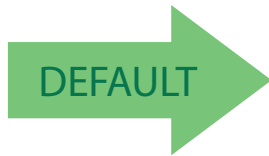

Expand Code128 to Code 39 = Disable

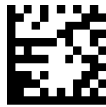

Expand Code128 to Code 39 = Enable

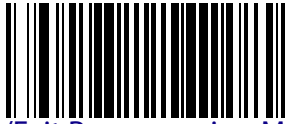

## Code 128 Minimum Read

This feature specifies the minimum number of consecutive Code 128 decodes before is accepted as good read.

To set this feature:

1. Scan the ENTER/EXIT Programming Mode bar code.
2. Scan your selection from the bar codes below. You'll need to cover any unused bar codes on this and the facing page to ensure that the scanner reads only the bar code you intend to scan.
3. Complete the programming sequence by scanning the ENTER/EXIT Programming Mode bar code.

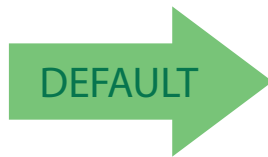

Code 128 Minimum Read = 1



Code 128 Minimum Read = 2



Code 128 Minimum Read = 3



Code 128 Minimum Read = 4

## Code 128 Correlation

Enables/disables character correlation for Code 128.

To set this feature:

1. Scan the ENTER/EXIT Programming Mode bar code.
2. Scan either the enable or disable bar code below. You'll need to cover any unused bar codes on this and the facing page to ensure that the scanner reads only the bar code you intend to scan.
3. Complete the programming sequence by scanning the ENTER/EXIT Programming Mode bar code.

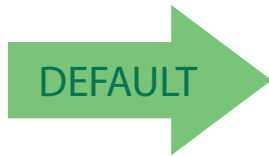

Code 128 Correlation = Disable



Code 128 Correlation = Enable



## Code 128 Length Control

This feature specifies whether variable-length or fixed-length decoding will be set for Code 128.

To set this feature:

1. Scan the ENTER/EXIT Programming Mode bar code.
2. Scan your selection from the bar codes below. You'll need to cover any unused bar codes on this and the facing page to ensure that the scanner reads only the bar code you intend to scan.
3. Complete the programming sequence by scanning the ENTER/EXIT Programming Mode bar code.

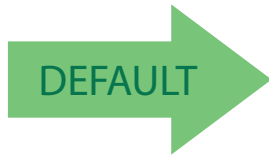

Code 128 Length Control = Variable Length



Code 128 Length Control = Fixed Length

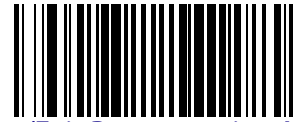

## Code 128 Length 1

If Code 128 Length Control is set to Fixed–Length decoding, this feature specifies Code 128 first fixed length. If Code 128 Length Control is set to Variable–Length decoding, this feature specifies the minimum label length.

To set this feature:

1. Scan the ENTER/EXIT Programming Mode bar code.
2. Scan the bar code, [Set Code 128 Length 1 on page 189](#) below. You'll need to cover any unused bar codes on this and the facing page to ensure that the scanner reads only the bar code you intend to scan.
3. Scan the appropriate digits from the [Alpha–Numeric Keypad in Appendix C](#) that represent the desired label length. The selectable range for this option is 01 to 80. Pad all single digit numbers with a leading zero to yield a two–digit entry (01–80).
4. Complete the programming sequence by scanning the ENTER/EXIT Programming Mode bar code.



Set Code 128 Length 1

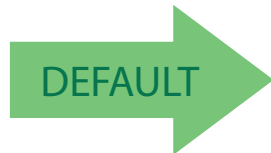

Default setting for this feature = 01

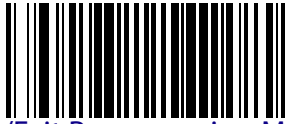

## Code 128 Length 2

If Code 128 Length Control is set to Fixed–Length decoding, this feature specifies Code 128 second fixed length. If Code 128 Length Control is set to Variable–Length decoding, this feature specifies the maximum label length.



### NOTE

**When in Fixed Length mode, if Length 2 is set to the value of 00 (zero), then only Length 1 will apply.**

To set this feature:

1. Scan the ENTER/EXIT Programming Mode bar code.
2. Scan the bar code, [Set Code 128 Length 2 on page 190](#) below. You'll need to cover any unused bar codes on this and the facing page to ensure that the scanner reads only the bar code you intend to scan.
3. Scan the appropriate digits from the [Alpha–Numeric Keypad in Appendix C](#) that represent the desired label length. The selectable range for this option is 01 to 80. Pad all single digit numbers with a leading zero to yield a two–digit entry (01–80).
4. Complete the programming sequence by scanning the ENTER/EXIT Programming Mode bar code.



Set Code 128 Length 2

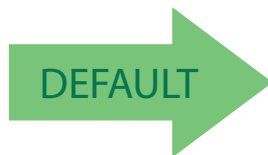

Default setting for this feature = 50 (length = 80)



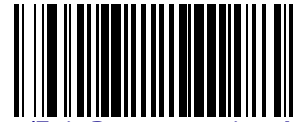

## Code 128 Stitching

Enables/disables stitching for Code 128 labels. When parts of a Code 128 bar code are presented to the scanner with this feature enabled, the bar code parts will be assembled by the scanner's software, and the data will be decoded if all bar code proofing requirements are met.

To set this feature:

1. Scan the ENTER/EXIT Programming Mode bar code.
2. Scan your selection from the bar codes below. You'll need to cover any unused bar codes on this and the facing page to ensure that the scanner reads only the bar code you intend to scan.
3. Complete the programming sequence by scanning the ENTER/EXIT Programming Mode bar code.



Code 128 Stitching = Disable



Code 128 Stitche = Enable



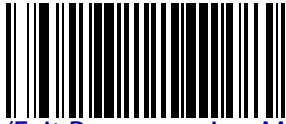

## EAN-128

### EAN-128 Enable

Enables/disables the ability of the scanner to translate EAN128 labels to the EAN128 data format.

To set this feature:

1. Scan the ENTER/EXIT Programming Mode bar code.
2. Scan either the enable or disable bar code below. You'll need to cover any unused bar codes on this and the facing page to ensure that the scanner reads only the bar code you intend to scan.
3. Complete the programming sequence by scanning the ENTER/EXIT Programming Mode bar code.

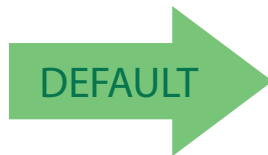

EAN-128 = Transmit EAN128 labels in Code128 data format



EAN-128 = Transmit EAN128 labels in EAN128 data format

## Interleaved 2 of 5 (I 2 OF 5)

### Interleaved 2 of 5 (I 2 OF 5) Enable

Enables/disables the ability of the scanner to decode Interleaved 2 of 5 labels.  
To set this feature:

1. Scan the ENTER/EXIT Programming Mode bar code.
2. Scan either the enable or disable bar code below. You'll need to cover any unused bar codes on this and the facing page to ensure that the scanner reads only the bar code you intend to scan.
3. Complete the programming sequence by scanning the ENTER/EXIT Programming Mode bar code.

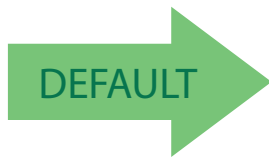

I 2 of 5 = Disable



I 2 of 5 = Enable

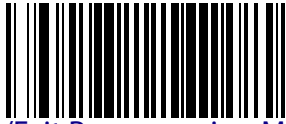

## I 2 of 5 Check Character Calculation

Enables/disables calculation and verification of an optional Interleaved 2 of 5 check character.



### NOTE

If check character calculation is disabled, the risk is increased that a misread can occur. When disabled, any check characters in a bar code are treated as data characters.

1. To set this feature:
2. Scan the ENTER/EXIT Programming Mode bar code.
3. Scan either the enable or disable bar code below. You'll need to cover any unused bar codes on this and the facing page to ensure that the scanner reads only the bar code you intend to scan.
4. Complete the programming sequence by scanning the ENTER/EXIT Programming Mode bar code.

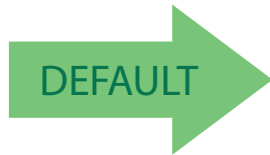

I 2 of 5 Check Character Calculation = Disable

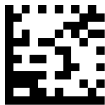

I 2 of 5 Check Character Calculation = Enable

## I 2 of 5 Check Character Transmission

Enables/disables transmission of an optional Interleaved 2 of 5 check character.



### NOTE

This feature applies only when I 2 of 5 Check Character Calculation is enabled. This item is ignored when the advanced feature, Full Label Edit, is enabled.

To set this feature:

1. Scan the ENTER/EXIT Programming Mode bar code.
2. Scan either the enable or disable bar code below. You'll need to cover any unused bar codes on this and the facing page to ensure that the scanner reads only the bar code you intend to scan.
3. Complete the programming sequence by scanning the ENTER/EXIT Programming Mode bar code.



I 2 of 5 Check Character Transmission = Disable



I 2 of 5 Check Character Transmission = Enable





## I 2 of 5 Minimum Read

This feature specifies the minimum number of consecutive I 2 of 5 decodes before is accepted as good read.

To set this feature:

1. Scan the ENTER/EXIT Programming Mode bar code.
2. Scan your selection from the bar codes below. You'll need to cover any unused bar codes on this and the facing page to ensure that the scanner reads only the bar code you intend to scan.
3. Complete the programming sequence by scanning the ENTER/EXIT Programming Mode bar code.

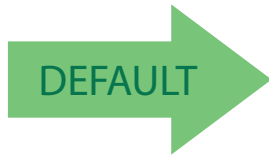

I 2 of 5 Minimum Read = 1



I 2 of 5 Minimum Read = 2



I 2 of 5 Minimum Read = 3



I 2 of 5 Minimum Read = 4

## I 2 of 5 Correlation

Enables/disables character correlation for I 2 of 5.

To set this feature:

1. Scan the ENTER/EXIT Programming Mode bar code.
2. Scan either the enable or disable bar code below. You'll need to cover any unused bar codes on this and the facing page to ensure that the scanner reads only the bar code you intend to scan.
3. Complete the programming sequence by scanning the ENTER/EXIT Programming Mode bar code.

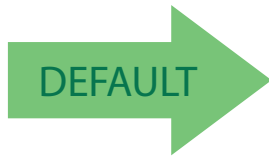

I 2 of 5 Correlation = Disable

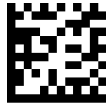

I 2 of 5 Correlation = Enable



## I 2 of 5 Length Control

This feature specifies whether variable-length or fixed-length decoding will be set for I 2 of 5.

To set this feature:

1. Scan the ENTER/EXIT Programming Mode bar code.
2. Scan your selection from the bar codes below. You'll need to cover any unused bar codes on this and the facing page to ensure that the scanner reads only the bar code you intend to scan.
3. Complete the programming sequence by scanning the ENTER/EXIT Programming Mode bar code.

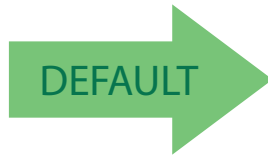

I 2 of 5 Length Control = Variable Length



I 2 of 5 Length Control = Fixed Length



## I 2 of 5 Length 1

If I 2 of 5 Length Control is set to Fixed-Length decoding, this feature specifies I 2 of 5 first fixed length. If I 2 of 5 Length Control is set to Variable-Length decoding, this feature specifies the minimum label length.

To set this feature:

1. Scan the ENTER/EXIT Programming Mode bar code.
2. Scan the bar code, [Set I 2 of 5 Length 1 on page 199](#) below. You'll need to cover any unused bar codes on this and the facing page to ensure that the scanner reads only the bar code you intend to scan.
3. Scan the appropriate digits from the [Alpha-Numeric Keypad in Appendix C](#) that represent the desired label length. The selectable range for this option is 02 to 50, even numbers only. Pad all single digit numbers with a leading zero to yield a two-digit entry (02–50).
4. Complete the programming sequence by scanning the ENTER/EXIT Programming Mode bar code.



Set I 2 of 5 Length 1

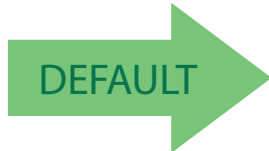

Default setting for this feature = 06



## I 2 of 5 Length 2

If I 2 of 5 Length Control is set to Fixed–Length decoding, this feature specifies I 2 of 5 second fixed length. If I 2 of 5 Length Control is set to Variable–Length decoding, this feature specifies the maximum label length.



**NOTE**

**When in Fixed Length mode, if Length 2 is set to the value of 00 (zero), then only Length 1 will apply.**

To set this feature:

1. Scan the ENTER/EXIT Programming Mode bar code.
2. Scan the bar code, [Set I 2 of 5 Length 2 on page 200](#) below. You’ll need to cover any unused bar codes on this and the facing page to ensure that the scanner reads only the bar code you intend to scan.
3. Scan the appropriate digits from the [Alpha–Numeric Keypad in Appendix C](#) that represent the desired label length. The selectable range for this option is 00, or 02 to 50; even numbers only. Pad all single digit numbers with a leading zero to yield a two–digit entry (02–50).
4. Complete the programming sequence by scanning the ENTER/EXIT Programming Mode bar code.



Set I 2 of 5 Length 2

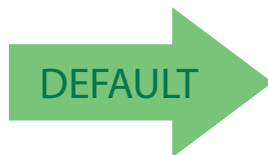

Default setting for this feature = 32 (length = 50)

## I 2 of 5 Stitching

Enables/disables stitching for I 2 of 5 labels. When parts of an I 2 of 5 bar code are presented to the scanner with this feature enabled, the bar code parts will be assembled by the scanner's software, and the data will be decoded if all bar code proofing requirements are met.

To set this feature:

1. Scan the ENTER/EXIT Programming Mode bar code.
2. Scan your selection from the bar codes below. You'll need to cover any unused bar codes on this and the facing page to ensure that the scanner reads only the bar code you intend to scan.
3. Complete the programming sequence by scanning the ENTER/EXIT Programming Mode bar code.

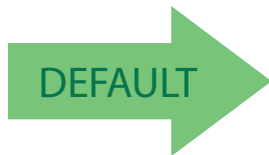

I 2 of 5 Stitching = Disable



I 2 of 5 Stitching = Enable



## Codabar

### Codabar Enable

Enables/disables the ability of the scanner to decode Codabar labels.

To set this feature:

1. Scan the ENTER/EXIT Programming Mode bar code.
2. Scan either the enable or disable bar code below. You'll need to cover any unused bar codes on this and the facing page to ensure that the scanner reads only the bar code you intend to scan.
3. Complete the programming sequence by scanning the ENTER/EXIT Programming Mode bar code.

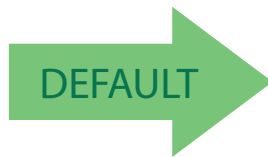

Codabar = Disable



Codabar = Enable

## Codabar Start Stop Character Transmission

Enables/disables transmission of Codabar start and stop characters.



**This item is ignored when the advanced feature, Full Label Edit, is enabled.**

### NOTE

To set this feature:

1. Scan the ENTER/EXIT Programming Mode bar code.
2. Scan either the enable or disable bar code below. You'll need to cover any unused bar codes on this and the facing page to ensure that the scanner reads only the bar code you intend to scan.
3. Complete the programming sequence by scanning the ENTER/EXIT Programming Mode bar code.



Codabar Start Stop Character Transmission = Disable



Codabar Start Stop Character Transmission = Enable





## Codabar Start Stop Character Set

This feature specifies the format of transmitted Codabar start/stop characters.

Options are:

- ABCD/TN\* E
- ABCD/ABCD
- abcd/tn\* e
- abcd/abcd

To set this feature:

1. Scan the ENTER/EXIT Programming Mode bar code.
2. Scan the bar code below or from the following page representing the desired option. You'll need to cover any unused bar codes and facing pages to ensure that the scanner reads only the bar code you intend to scan.
3. Complete the programming sequence by scanning the ENTER/EXIT Programming Mode bar code.



Codabar Start Stop Character Set = ABCD/TN\* E



Codabar Start Stop Character Set = ABCD/ABCD



Codabar Start Stop Character Set = abcd/tn\* e



Codabar Start Stop Character Set = abcd/abcd



## Codabar Start Stop Character Match

Enables/disables the requirement that Codabar start and stop characters match.

To set this feature:

1. Scan the ENTER/EXIT Programming Mode bar code.
2. Scan either the enable or disable bar code below. You'll need to cover any unused bar codes on this and the facing page to ensure that the scanner reads only the bar code you intend to scan.
3. Complete the programming sequence by scanning the ENTER/EXIT Programming Mode bar code.

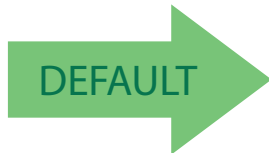

Codabar Start Stop Character Match = Disable



Codabar Start Stop Character Match = Enable

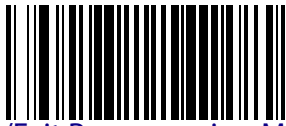

## Codabar Check Character Calculation

Enables/disables calculation and verification of an optional Codabar check character.



### NOTE

If check character calculation is disabled, the risk is increased that a misread can occur. When disabled, any check characters in a bar code are treated as data characters.

To set this feature:

1. Scan the ENTER/EXIT Programming Mode bar code.
2. Scan either the enable or disable bar code below. You'll need to cover any unused bar codes on this and the facing page to ensure that the scanner reads only the bar code you intend to scan.
3. Complete the programming sequence by scanning the ENTER/EXIT Programming Mode bar code.

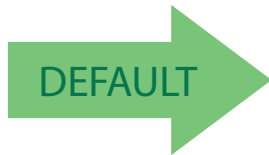

Codabar Check Character Calculation = Disable



Codabar Check Character Calculation = Enable



## Codabar Check Character Transmission

Enables/disables transmission of an optional Codabar check character.



### NOTE

Applies only when Codabar Check Character Calculation is enabled. This item is ignored when the advanced feature, Full Label Edit, is enabled.

To set this feature:

1. Scan the ENTER/EXIT Programming Mode bar code.
2. Scan either the enable or disable bar code below. You'll need to cover any unused bar codes on this and the facing page to ensure that the scanner reads only the bar code you intend to scan.
3. Complete the programming sequence by scanning the ENTER/EXIT Programming Mode bar code.



Codabar Check Character Transmission = Disable



Codabar Check Character Transmission = Enable



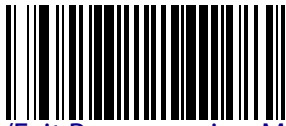

## Codabar Minimum Read

This feature specifies the minimum number of consecutive Codabar decodes before is accepted as good read.

To set this feature:

1. Scan the ENTER/EXIT Programming Mode bar code.
2. Scan your selection from the bar codes below. You'll need to cover any unused bar codes on this and the facing page to ensure that the scanner reads only the bar code you intend to scan.
3. Complete the programming sequence by scanning the ENTER/EXIT Programming Mode bar code.

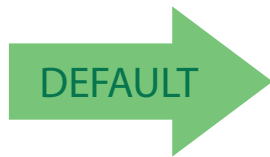

Codabar Minimum Read = 1



Codabar Minimum Read = 2



Codabar Minimum Read = 3



Codabar Minimum Read = 4

## Codabar Correlation

Enables/disables character correlation for Codabar.

To set this feature:

1. Scan the ENTER/EXIT Programming Mode bar code.
2. Scan either the enable or disable bar code below. You'll need to cover any unused bar codes on this and the facing page to ensure that the scanner reads only the bar code you intend to scan.
3. Complete the programming sequence by scanning the ENTER/EXIT Programming Mode bar code.

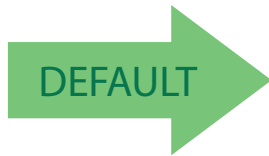

Codabar Correlation = Disable

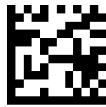

Codabar Correlation = Enable



## Codabar Length Control

This feature specifies whether variable-length or fixed-length decoding will be set for Codabar.

To set this feature:

1. Scan the ENTER/EXIT Programming Mode bar code.
2. Scan your selection from the bar codes below. You'll need to cover any unused bar codes on this and the facing page to ensure that the scanner reads only the bar code you intend to scan.
3. Complete the programming sequence by scanning the ENTER/EXIT Programming Mode bar code.

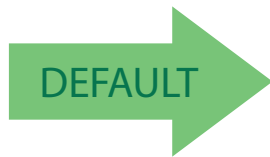

Codabar Length Control = Variable Length



Codabar Length Control = Fixed Length

## Codabar Length 1

If Codabar Length Control is set to Fixed–Length decoding, this feature specifies Codabar first fixed length. If Codabar Length Control is set to Variable–Length decoding, this feature specifies the minimum label length.

To set this feature:

1. Scan the ENTER/EXIT Programming Mode bar code.
2. Scan the bar code, [Set Codabar Length 1 on page 211](#) below. You'll need to cover any unused bar codes on this and the facing page to ensure that the scanner reads only the bar code you intend to scan.
3. Scan the appropriate digits from the [Alpha–Numeric Keypad in Appendix C](#) that represent the desired label length. The selectable range for this option is 03 to 50. Pad all single digit numbers with a leading zero to yield a two–digit entry (03–50).
4. Complete the programming sequence by scanning the ENTER/EXIT Programming Mode bar code.



Set Codabar Length 1

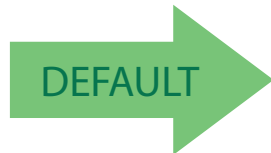

Default setting for this feature = 03

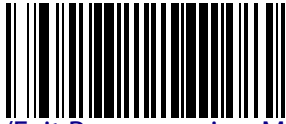

## Codabar Length 2

If Codabar Length Control is set to Fixed–Length decoding, this feature specifies Codabar second fixed length. If Codabar Length Control is set to Variable–Length decoding, this feature specifies the maximum label length.



**NOTE**

**When in Fixed Length mode, if Length 2 is set to the value of 00 (zero), then only Length 1 will apply.**

To set this feature:

1. Scan the ENTER/EXIT Programming Mode bar code.
2. Scan the bar code, [Set Codabar Length 2 on page 212](#) below. You’ll need to cover any unused bar codes on this and the facing page to ensure that the scanner reads only the bar code you intend to scan.
3. Scan the appropriate digits from the [Alpha–Numeric Keypad in Appendix C](#) that represent the desired label length. The selectable range for this option is 00 (meaning ignore this length), or 03 to 50. Pad all single digit numbers with a leading zero to yield a two–digit entry (03–50).
4. Complete the programming sequence by scanning the ENTER/EXIT Programming Mode bar code.



Set Codabar Length 2

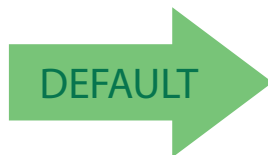

Default setting for this feature = 32 (length = 50)

## Codabar Stitching

Enables/disables stitching for Codabar labels. When parts of a Codabar bar code are presented to the scanner with this feature enabled, the bar code parts will be assembled by the scanner's software, and the data will be decoded if all bar code proofing requirements are met.

To set this feature:

1. Scan the ENTER/EXIT Programming Mode bar code.
2. Scan your selection from the bar codes below. You'll need to cover any unused bar codes on this and the facing page to ensure that the scanner reads only the bar code you intend to scan.
3. Complete the programming sequence by scanning the ENTER/EXIT Programming Mode bar code.

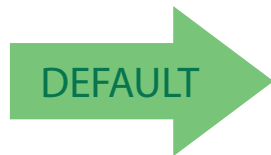

Codabar Stitching = Disable



Codabar Stitching = Enable

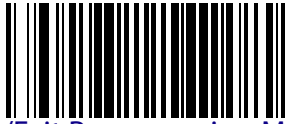

## Codabar Require Margins

Enables/disables the requirement that quiet zones be present in a Codabar bar code.

To set this feature:

1. Scan the ENTER/EXIT Programming Mode bar code.
2. Scan either the enable or disable bar code below. You'll need to cover any unused bar codes on this and the facing page to ensure that the scanner reads only the bar code you intend to scan.
3. Complete the programming sequence by scanning the ENTER/EXIT Programming Mode bar code.

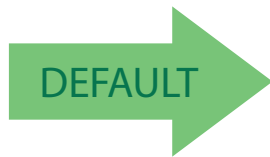

Codabar Require Margins = Quiet Zones Not Required



Codabar Require Margins = Quiet Zones Required



## Code 93

### Code 93 Enable

Enables/disables the ability of the scanner to decode Code 93 labels.

To set this feature:

1. Scan the ENTER/EXIT Programming Mode bar code.
2. Scan either the enable or disable bar code below. You'll need to cover any unused bar codes on this and the facing page to ensure that the scanner reads only the bar code you intend to scan.
3. Complete the programming sequence by scanning the ENTER/EXIT Programming Mode bar code.

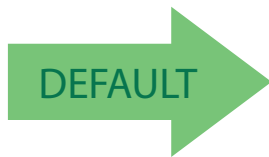

Code 93 = Disable



Code 93 = Enable



## Code 93 Minimum Read

This feature specifies the minimum number of consecutive Code 93 decodes before is accepted as good read.

To set this feature:

1. Scan the ENTER/EXIT Programming Mode bar code.
2. Scan your selection from the bar codes below. You'll need to cover any unused bar codes on this and the facing page to ensure that the scanner reads only the bar code you intend to scan.
3. Complete the programming sequence by scanning the ENTER/EXIT Programming Mode bar code.

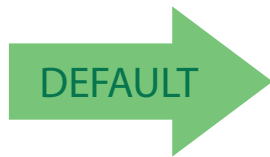

Code 93 Minimum Read = 1



Code 93 Minimum Read = 2



Code 93 Minimum Read = 3



Code 93 Minimum Read = 4

## Code 93 Correlation

Enables/disables character correlation for Code 93.

To set this feature:

1. Scan the ENTER/EXIT Programming Mode bar code.
2. Scan either the enable or disable bar code below. You'll need to cover any unused bar codes on this and the facing page to ensure that the scanner reads only the bar code you intend to scan.
3. Complete the programming sequence by scanning the ENTER/EXIT Programming Mode bar code.

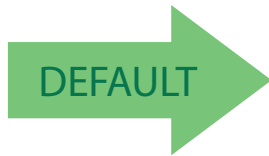

Code 93 Correlation = Disable

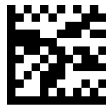

Code 93 Correlation = Enable



## Code 93 Length Control

This feature specifies whether variable-length or fixed-length decoding will be set for Code 93.

To set this feature:

1. Scan the ENTER/EXIT Programming Mode bar code.
2. Scan your selection from the bar codes below. You'll need to cover any unused bar codes on this and the facing page to ensure that the scanner reads only the bar code you intend to scan.
3. Complete the programming sequence by scanning the ENTER/EXIT Programming Mode bar code.

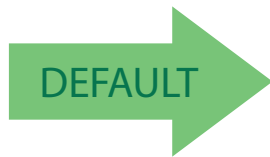

Code 93 Length Control = Variable Length



Code 93 Length Control = Fixed Length

## Code 93 Length 1

If Code 93 Length Control is set to Fixed–Length decoding, this feature specifies Code 93 first fixed length. If Code 93 Length Control is set to Variable–Length decoding, this feature specifies the minimum label length.

To set this feature:

1. Scan the ENTER/EXIT Programming Mode bar code.
2. Scan the bar code, [Set Code 93 Length 1 on page 219](#) below. You'll need to cover any unused bar codes on this and the facing page to ensure that the scanner reads only the bar code you intend to scan.
3. Scan the appropriate digits from the [Alpha–Numeric Keypad in Appendix C](#) that represent the desired label length. The selectable range for this option is 01 to 50. Pad all single digit numbers with a leading zero to yield a two–digit entry (01–50).
4. Complete the programming sequence by scanning the ENTER/EXIT Programming Mode bar code.



Set Code 93 Length 1

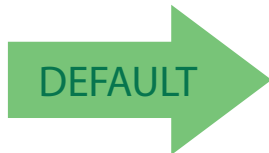

Default setting for this feature = 01

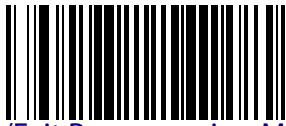

## Code 93 Length 2

If Code 93 Length Control is set to Fixed–Length decoding, this feature specifies Code 93 second fixed length. If Code 93 Length Control is set to Variable–Length decoding, this feature specifies the maximum label length.



**When in Fixed Length mode, if Fixed Length 2 is set to the value of 00 (zero), then only Length 1 will apply.**

**NOTE**

To set this feature:

1. Scan the ENTER/EXIT Programming Mode bar code.
2. Scan the bar code, [Set Code 93 Length 2 on page 220](#) below. You’ll need to cover any unused bar codes on this and the facing page to ensure that the scanner reads only the bar code you intend to scan.
3. Scan the appropriate digits from the [Alpha–Numeric Keypad in Appendix C](#) that represent the desired label length. The selectable range for this option is 00 (meaning ignore this length), or 01 to 50. Pad all single digit numbers with a leading zero to yield a two–digit entry (01–50).
4. Complete the programming sequence by scanning the ENTER/EXIT Programming Mode bar code.



Set Code 93 Length 2

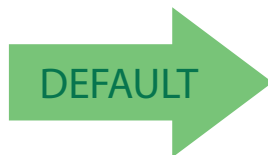

Default setting for this feature = 32 (length = 50)

## Code 93 Stitching

Enables/disables stitching for Code 93 labels. When parts of a Code 93 bar code are presented to the scanner with this feature enabled, the bar code parts will be assembled by the scanner's software, and the data will be decoded if all bar code proofing requirements are met.

To set this feature:

1. Scan the ENTER/EXIT Programming Mode bar code.
2. Scan your selection from the bar codes below. You'll need to cover any unused bar codes on this and the facing page to ensure that the scanner reads only the bar code you intend to scan.
3. Complete the programming sequence by scanning the ENTER/EXIT Programming Mode bar code.



Code 93 Stitching = Disable



Code 93 Stitching = Enable





## MSI

### MSI Enable

Enables/disables the ability of the scanner to decode MSI labels.

To set this feature:

1. Scan the ENTER/EXIT Programming Mode bar code.
2. Scan either the enable or disable bar code below. You'll need to cover any unused bar codes on this and the facing page to ensure that the scanner reads only the bar code you intend to scan.
3. Complete the programming sequence by scanning the ENTER/EXIT Programming Mode bar code.

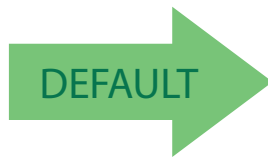

MSI = Disable



MSI = Enable



## MSI Check Character Calculation

Enables/disables calculation and verification of optional MSI check characters.



### NOTE

If check character calculation is disabled, the risk is increased that a misread can occur. When disabled, any check characters in a bar code are treated as data characters.

To set this feature:

1. Scan the ENTER/EXIT Programming Mode bar code.
2. Scan either the enable or disable bar code below. You'll need to cover any unused bar codes on this and the facing page to ensure that the scanner reads only the bar code you intend to scan.
3. Complete the programming sequence by scanning the ENTER/EXIT Programming Mode bar code.



MSI Check Character Calculation = Disable



MSI Check Character Calculation = Enable





## MSI Number of Check Characters

Specifies number of MSI check characters to be calculated and verified.



**Check characters are always modulus 10.**

### NOTE

To set this feature:

1. Scan the ENTER/EXIT Programming Mode bar code.
2. Scan the bar code below representing the desired number of MSI check characters to be calculated and verified. You'll need to cover any unused bar codes on this and the facing page to ensure that the scanner reads only the bar code you intend to scan.
3. Complete the programming sequence by scanning the ENTER/EXIT Programming Mode bar code.

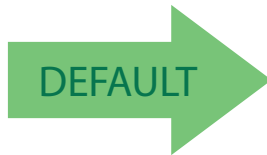

MSI Number of Check Characters = 1



MSI Number of Check Characters = 2

## MSI Check Character Transmission

Enables/disables transmission of optional MSI check characters.



### NOTE

**This feature applies only when MSI Check Character Calculation on page 223 is enabled. This item is ignored when the advanced feature, Full Label Edit, is enabled.**

To set this feature:

1. Scan the ENTER/EXIT Programming Mode bar code.
2. Scan either the enable or disable bar code below. You'll need to cover any unused bar codes on this and the facing page to ensure that the scanner reads only the bar code you intend to scan.
3. Complete the programming sequence by scanning the ENTER/EXIT Programming Mode bar code.



MSI Check Character Transmission = Disable



MSI Check Character Transmission = Enable



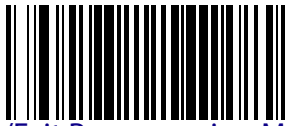

## MSI Minimum Read

This feature specifies the minimum number of consecutive MSI decodes before is accepted as good read.

To set this feature:

1. Scan the ENTER/EXIT Programming Mode bar code.
2. Scan your selection from the bar codes below. You'll need to cover any unused bar codes on this and the facing page to ensure that the scanner reads only the bar code you intend to scan.
3. Complete the programming sequence by scanning the ENTER/EXIT Programming Mode bar code.

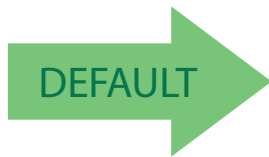

MSI Minimum Read = 1



MSI Minimum Read = 2



MSI Minimum Read = 3



MSI Minimum Read = 4

## MSI Correlation

Enables/disables character correlation for MSI.

To set this feature:

1. Scan the ENTER/EXIT Programming Mode bar code.
2. Scan either the enable or disable bar code below. You'll need to cover any unused bar codes on this and the facing page to ensure that the scanner reads only the bar code you intend to scan.
3. Complete the programming sequence by scanning the ENTER/EXIT Programming Mode bar code.

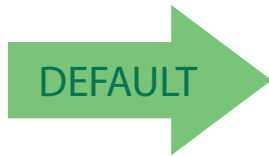

MSI Correlation = Disable

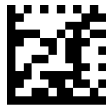

MSI Correlation = Enable



## MSI Length Control

This feature specifies whether variable-length or fixed-length decoding will be set for MSI.

To set this feature:

1. Scan the ENTER/EXIT Programming Mode bar code.
2. Scan your selection from the bar codes below. You'll need to cover any unused bar codes on this and the facing page to ensure that the scanner reads only the bar code you intend to scan.
3. Complete the programming sequence by scanning the ENTER/EXIT Programming Mode bar code.

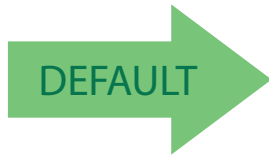

MSI Length Control = Variable Length



MSI Length Control = Fixed Length



## MSI Length 1

If MSI Length Control is set to Fixed–Length decoding, this feature specifies MSI first fixed length. If MSI Length Control is set to Variable–Length decoding, this feature specifies the minimum label length.

To set this feature:

1. Scan the ENTER/EXIT Programming Mode bar code.
2. Scan the bar code, [Set MSI Length 1 on page 229](#) below. You'll need to cover any unused bar codes on this and the facing page to ensure that the scanner reads only the bar code you intend to scan.
3. Scan the appropriate digits from the [Alpha–Numeric Keypad in Appendix C](#) that represent the desired label length. The selectable range for this option is 4 to 16. Pad all single digit numbers with a leading zero to yield a two–digit entry (04–16).
4. Complete the programming sequence by scanning the ENTER/EXIT Programming Mode bar code.



Set MSI Length 1

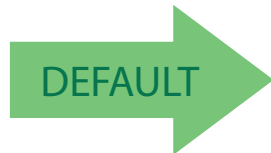

Default setting for this feature = 04

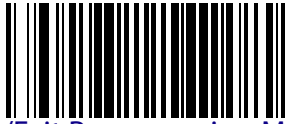

## MSI Length 2

If MSI Length Control is set to Fixed–Length decoding, this feature specifies MSI second fixed length. If MSI Length Control is set to Variable–Length decoding, this feature specifies the maximum label length.



**When in Fixed Length mode, if Length 2 is set to the value 00 (zero), then only Length 1 will apply.**

**NOTE**

To set this feature:

1. Scan the ENTER/EXIT Programming Mode bar code.
2. Scan the bar code, [Set MSI Length 2 on page 230](#) below. You’ll need to cover any unused bar codes on this and the facing page to ensure that the scanner reads only the bar code you intend to scan.
3. Scan the appropriate digits from the [Alpha–Numeric Keypad in Appendix C](#) that represent the desired label length. The selectable range for this option is 00 (meaning ignore this length), or 04 to 16. Pad all single digit numbers with a leading zero to yield a two–digit entry (00, 04–16).
4. Complete the programming sequence by scanning the ENTER/EXIT Programming Mode bar code.



Set MSI Length 2

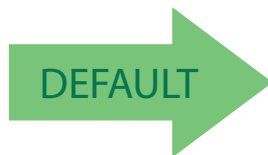

Default setting for this feature = 10 (length = 16)



## MSI Stitching

Enables/disables stitching for MSI labels. When parts of an MSI bar code are presented to the scanner with this feature enabled, the bar code parts will be assembled by the scanner's software, and the data will be decoded if all bar code proofing requirements are met.

To set this feature:

1. Scan the ENTER/EXIT Programming Mode bar code.
2. Scan your selection from the bar codes below. You'll need to cover any unused bar codes on this and the facing page to ensure that the scanner reads only the bar code you intend to scan.
3. Complete the programming sequence by scanning the ENTER/EXIT Programming Mode bar code.

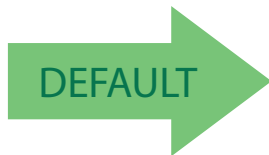

MSI Stitching = Disable

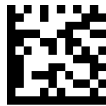

MSI Stitching = Enable



## Standard 2 of 5

### Standard 2 of 5 Enable

Enables/disables the ability of the scanner to decode Standard 2 of 5 labels.  
To set this feature:

1. Scan the ENTER/EXIT Programming Mode bar code.
2. Scan either the enable or disable bar code below. You'll need to cover any unused bar codes on this and the facing page to ensure that the scanner reads only the bar code you intend to scan.
3. Complete the programming sequence by scanning the ENTER/EXIT Programming Mode bar code.

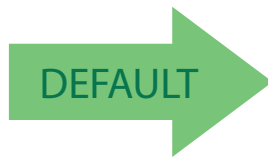

Standard 2 of 5 = Disable



Standard 2 of 5 = Enable

## Standard 2 of 5 Check Character Calculation

Enables/disables calculation and verification of an optional Standard 2 of 5 check character.



### NOTE

If check character calculation is disabled, the risk is increased that a misread can occur. When disabled, any check character in a bar code is treated as data character.

To set this feature:

1. Scan the ENTER/EXIT Programming Mode bar code.
2. Scan either the enable or disable bar code below. You'll need to cover any unused bar codes on this and the facing page to ensure that the scanner reads only the bar code you intend to scan.
3. Complete the programming sequence by scanning the ENTER/EXIT Programming Mode bar code.

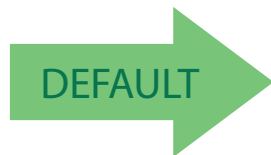

Standard 2 of 5 Check Character Calculation = Disable



Standard 2 of 5 Check Character Calculation = Enable

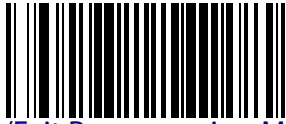

## Standard 2 of 5 Check Character Transmission

Enables/disables transmission of an optional Standard 2 of 5 check character.



### NOTE

**This feature applies only when Standard 2 of 5 Check Character Calculation on page 233 is enabled. This item is ignored when the advanced feature, Full Label Edit, is enabled.**

To set this feature:

1. Scan the ENTER/EXIT Programming Mode bar code.
2. Scan either the enable or disable bar code below. You'll need to cover any unused bar codes on this and the facing page to ensure that the scanner reads only the bar code you intend to scan.
3. Complete the programming sequence by scanning the ENTER/EXIT Programming Mode bar code.



Standard 2 of 5 Check Character Transmission = Disable



Standard 2 of 5 Check Character Transmission = Enable



## Standard 2 of 5 Minimum Read

This feature specifies the minimum number of consecutive Standard 2 of 5 decodes before is accepted as good read.

To set this feature:

1. Scan the ENTER/EXIT Programming Mode bar code.
2. Scan your selection from the bar codes below. You'll need to cover any unused bar codes on this and the facing page to ensure that the scanner reads only the bar code you intend to scan.
3. Complete the programming sequence by scanning the ENTER/EXIT Programming Mode bar code.

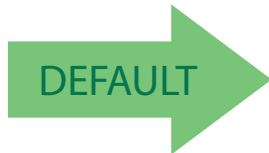

Standard 2 of 5 Minimum Read = 1



Standard 2 of 5 Minimum Read = 2



Standard 2 of 5 Minimum Read = 3



Standard 2 of 5 Minimum Read = 4



## Standard 2 of 5 Correlation

Enables/disables character correlation for Standard 2 of 5.

To set this feature:

1. Scan the ENTER/EXIT Programming Mode bar code.
2. Scan either the enable or disable bar code below. You'll need to cover any unused bar codes on this and the facing page to ensure that the scanner reads only the bar code you intend to scan.
3. Complete the programming sequence by scanning the ENTER/EXIT Programming Mode bar code.

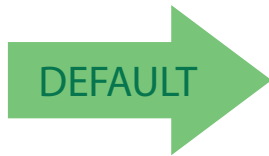

Standard 2 of 5 Correlation = Disable



Standard 2 of 5 Correlation = Enable

## Standard 2 of 5 Length Control

This feature specifies whether variable-length or fixed-length decoding will be set for Standard 2 of 5.

To set this feature:

1. Scan the ENTER/EXIT Programming Mode bar code.
2. Scan your selection from the bar codes below. You'll need to cover any unused bar codes on this and the facing page to ensure that the scanner reads only the bar code you intend to scan.
3. Complete the programming sequence by scanning the ENTER/EXIT Programming Mode bar code.

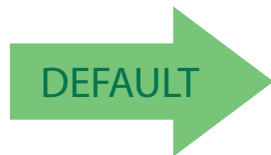

Standard 2 of 5 Length Control = Variable Length

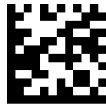

Standard 2 of 5 Length Control = Fixed Length



## Standard 2 of 5 Length 1

If Standard 2 of 5 Length Control is set to Fixed–Length decoding, this feature specifies Standard 2 of 5 first fixed length. If Standard 2 of 5 Length Control is set to Variable–Length decoding, this feature specifies the minimum label length.

To set this feature:

1. Scan the ENTER/EXIT Programming Mode bar code.
2. Scan the bar code, [Set Standard 2 of 5 Length 1 on page 238](#) below. You'll need to cover any unused bar codes on this and the facing page to ensure that the scanner reads only the bar code you intend to scan.
3. Scan the appropriate digits from the [Alpha–Numeric Keypad in Appendix C](#) that represent the desired label length. The selectable range for this option is 1 to 50. Pad all single digit numbers with a leading zero to yield a two–digit entry (01–50).
4. Complete the programming sequence by scanning the ENTER/EXIT Programming Mode bar code.



Set Standard 2 of 5 Length 1

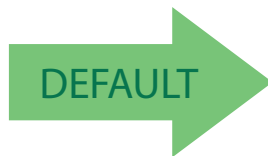

Default setting for this feature = 08



## Standard 2 of 5 Length 2

If Standard 2 of 5 Length Control is set to Fixed–Length decoding, this feature specifies Standard 2 of 5 second fixed length. If Standard 2 of 5 Length Control is set to Variable–Length decoding, this feature specifies the maximum label length.



**When in Fixed Length mode, if Length 2 is set to the value of 00 (zero), then only Length 1 will apply.**

### NOTE

To set this feature:

1. Scan the ENTER/EXIT Programming Mode bar code.
2. Scan the bar code, [Set Standard 2 of 5 Length 2 on page 239](#) below. You'll need to cover any unused bar codes on this and the facing page to ensure that the scanner reads only the bar code you intend to scan.
3. Scan the appropriate digits from the [Alpha–Numeric Keypad in Appendix C](#) that represent the desired label length. The selectable range for this option is 1 to 50. Pad all single digit numbers with a leading zero to yield a two–digit entry (01–50).
4. Complete the programming sequence by scanning the ENTER/EXIT Programming Mode bar code.



Set Standard 2 of 5 Length 2

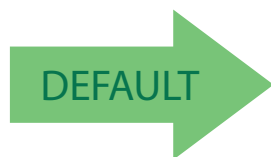

Default setting for this feature = 32 (length = 50)



## Standard 2 of 5 Stitching

Enables/disables stitching for Standard 2 of 5 labels. When parts of a Standard 2 of 5 bar code are presented to the scanner with this feature enabled, the bar code parts will be assembled by the scanner’s software, and the data will be decoded if all bar code proofing requirements are met.



**This applies when Standard 2 of 5 Length Control on page 237 is set to fixed-length decoding.**

### NOTE

To set this feature:

1. Scan the ENTER/EXIT Programming Mode bar code.
2. Scan your selection from the bar codes below. You’ll need to cover any unused bar codes on this and the facing page to ensure that the scanner reads only the bar code you intend to scan.
3. Complete the programming sequence by scanning the ENTER/EXIT Programming Mode bar code.

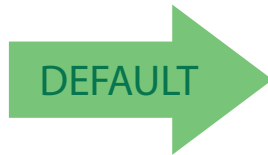

Standard 2 of 5 Stitching = Disable



Standard 2 of 5 Stitching = Enable



## 2D Symbologies/Bar Codes



### NOTE

If the scanner's interface type must be changed, always be sure that interface configuration is the **FIRST** item scanned during a programming session. (Selecting an interface type resets **ALL** other configuration items — including symbology programming — to the factory default for that interface type.)

The following pages contain configuration information concerning the various 2D bar code types (symbologies) the scanner supports.

<b>DATA MATRIX</b> starting on page 242
<b>PDF 417</b> starting on page 246
<b>MICRO PDF 417</b> starting on page 250
<b>QR CODE</b> starting on page 254
<b>MICRO QR CODE</b> starting on page 259
<b>AZTEC CODE</b> starting on page 262

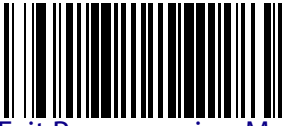

## Data Matrix

### Data Matrix Enable

Enables/disables the ability of the scanner to decode Data Matrix labels.  
To set this feature:

1. Scan the Enter/Exit Programming Mode bar code.
2. Scan either the enable or disable bar code below. You'll need to cover any unused bar codes on this and the facing page to ensure that the scanner reads only the bar code you intend to scan.
3. Complete the programming sequence by scanning the Enter/Exit Programming Mode bar code.

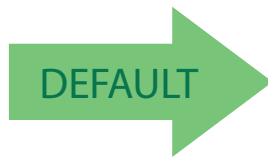

Data Matrix = Disable



Data Matrix = Enable

## Data Matrix Length Control

**Fixed Length Decoding** — When fixed length decoding is enabled, the scanner will decode a bar code if the label length matches one of the configurable fixed lengths.

**Variable Length Decoding** — When variable length decoding is enabled, the scanner will decode a bar code if the label length falls in the range of the configurable minimum and maximum length.

Configuring Fixed Length Decoding:

1. Scan the ENTER/EXIT Programming Mode bar code.
2. Scan the Fixed Length Decoding bar code.
3. Scan the ENTER/EXIT Programming Mode bar code.
4. Set Length 1 to the first fixed length using the [Data Matrix Length 1, Length 2 Programming Instructions on page 244](#) that follow this page.
5. Set Length 2 to the second fixed length (or to '0000' if there is only one fixed length) using the [Data Matrix Length 1, Length 2 Programming Instructions on page 244](#).

Configuring Variable Length Decoding:

1. Scan the ENTER/EXIT Programming Mode bar code.
2. Scan the Variable Length Decoding bar code.
3. Scan the ENTER/EXIT Programming Mode bar code.
4. Set Length 1 to the minimum length using the [Data Matrix Length 1, Length 2 Programming Instructions on page 244](#) that follow this page.
5. Set Length 2 to the maximum length using the [Data Matrix Length 1, Length 2 Programming Instructions on page 244](#).

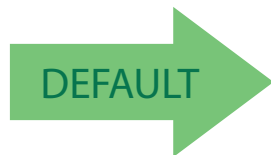

Data Matrix Length Control = Variable Length



Data Matrix Length Control = Fixed Length



### Data Matrix Length 1, Length 2 Programming Instructions

If Data Matrix Length Control is set to Fixed–Length decoding, this feature specifies Data Matrix first fixed length. If Data Matrix Length Control is set to Variable–Length decoding, this feature specifies the minimum label length.



**For Data Matrix bar codes, only the data characters are included in the length calculations.**

**NOTE**

To set this feature:

1. Scan the ENTER/EXIT Programming Mode bar code.
2. Scan the bar code, [Set Data Matrix Length 1 on page 244](#) or [Set Data Matrix Length 2 on page 244](#) below. You’ll need to cover any unused bar codes on this and the facing page to ensure that the scanner reads only the bar code you intend to scan.
3. Scan the appropriate digits from the [Alpha–Numeric Keypad in Appendix C](#) that represent the desired label length. The selectable range for this option is 0001 to 3116. Pad all numbers with leading zeros to yield a four–digit entry (0001–3116).
4. Complete the programming sequence by scanning the ENTER/EXIT Programming Mode bar code.

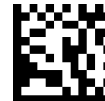

Set Data Matrix Length 1  
Default setting for this feature = 0001



Set Data Matrix Length 2  
Default setting for this feature = 0320 (length = 800)

## GS1 Datamatrix Enable

Enables/disables the ability of the scanner to decode GS1 Datamatrix labels.

To set this feature:

1. Scan the Enter/Exit Programming Mode bar code.
2. Scan either the enable or disable bar code below. You'll need to cover any unused bar codes on this and the facing page to ensure that the scanner reads only the bar code you intend to scan.
3. Complete the programming sequence by scanning the Enter/Exit Programming Mode bar code.

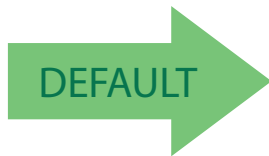

GS1 Datamatrix disabled



GS1 Datamatrix enabled

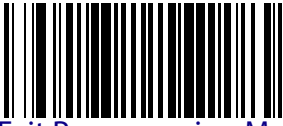

## PDF 417

### PDF 417 Enable

Enables the processing of PDF417 labels.

To set this feature:

1. Scan the Enter/Exit Programming Mode bar code.
2. Scan either the enable or disable bar code below. You'll need to cover any unused bar codes on this and the facing page to ensure that the scanner reads only the bar code you intend to scan.
3. Complete the programming sequence by scanning the Enter/Exit Programming Mode bar code.

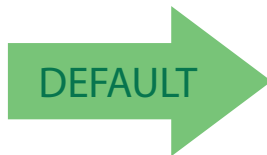

PDF 417 = Disable



PDF 417 = Enable



## PDF 417 Length Control

**Fixed Length Decoding** — When fixed length decoding is enabled, the scanner will decode a bar code if the label length matches one of the configurable fixed lengths.

**Variable Length Decoding** — When variable length decoding is enabled, the scanner will decode a bar code if the label length falls in the range of the configurable minimum and maximum length.

Configuring Fixed Length Decoding:

1. Scan the ENTER/EXIT Programming Mode bar code.
2. Scan the Fixed Length Decoding bar code.
3. Scan the ENTER/EXIT Programming Mode bar code.
4. Set Length 1 to the first fixed length using the [PDF 417 Length 1, Length 2 Programming Instructions on page 248](#) that follow this page.
5. Set Length 2 to the second fixed length (or to '0000' if there is only one fixed length) using the [PDF 417 Length 1, Length 2 Programming Instructions on page 248](#).

**Configuring Variable Length Decoding:**

1. Scan the ENTER/EXIT Programming Mode bar code.
2. Scan the Variable Length Decoding bar code.
3. Scan the ENTER/EXIT Programming Mode bar code.
4. Set Length 1 to the minimum length using the [PDF 417 Length 1, Length 2 Programming Instructions on page 248](#) that follow this page.
5. Set Length 2 to the maximum length using the [PDF 417 Length 1, Length 2 Programming Instructions on page 248](#).

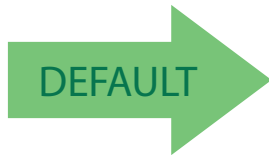

PDF 417 Length Control = Variable Length



PDF 417 Length Control = Fixed Length



### PDF 417 Length 1, Length 2 Programming Instructions

If PDF417 Length Control is set to Fixed–Length decoding, this feature specifies PDF417 first fixed length. If PDF417 Length Control is set to Variable–Length decoding, this feature specifies the minimum label length.



**NOTE**

This tag is only valid for units with a model id that supports PDF. Length 1 is the minimum label length if in variable length mode, or the first fixed length if in fixed length mode. Length 2 is the maximum label length if in variable length mode, or the second fixed length if in fixed length mode. Length includes the bar code's data characters only. Any value > 2710 will be considered to be 2710.

To set this feature:

1. Scan the ENTER/EXIT Programming Mode bar code.
2. Scan the bar code, [Set PDF 417 Length 1 on page 248](#) or [Set PDF 417 Length 2 on page 248](#) below. You'll need to cover any unused bar codes on this and the facing page to ensure that the scanner reads only the bar code you intend to scan.
3. Scan the appropriate digits from the [Alpha–Numeric Keypad in Appendix C](#) that represent the desired label length. The selectable range for this option is 0001 to 2710. Pad all numbers with leading zeros to yield a four–digit entry (0001–2710).
4. Complete the programming sequence by scanning the ENTER/EXIT Programming Mode bar code.



Set PDF 417 Length 1  
Default setting for this feature = 0001



Set PDF 417 Length 2  
Default setting for this feature = 0A96 (length = 2710)

## PDF 417 Read Option

This feature specifies an additional read control option for PDF 417 bar codes. To set this feature:

1. Scan the Enter/Exit Programming Mode bar code.
2. Scan either the enable or disable bar code below. You'll need to cover any unused bar codes on this and the facing page to ensure that the scanner reads only the bar code you intend to scan.
3. Complete the programming sequence by scanning the Enter/Exit Programming Mode bar code.

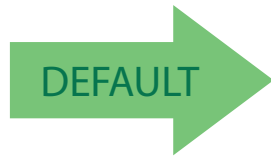

PDF 417 Read Option = None



PDF 417 Read Option = Turn Off Codeword  
Length Checking

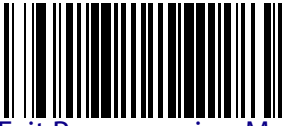

## Micro PDF 417

### Micro PDF 417 Enable

Enables/disables the ability of the scanner to decode Micro PDF 417 labels.  
To set this feature:

1. Scan the Enter/Exit Programming Mode bar code.
2. Scan either the enable or disable bar code below. You'll need to cover any unused bar codes on this and the facing page to ensure that the scanner reads only the bar code you intend to scan.
3. Complete the programming sequence by scanning the Enter/Exit Programming Mode bar code.

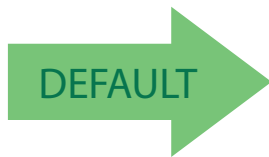

Micro PDF 417 = Disable



Micro PDF 417 = Enable

## Micro PDF 417 Length Control

**Fixed Length Decoding** — When fixed length decoding is enabled, the scanner will decode a bar code if the label length matches one of the configurable fixed lengths.

**Variable Length Decoding** — When variable length decoding is enabled, the scanner will decode a bar code if the label length falls in the range of the configurable minimum and maximum length.

Configuring Fixed Length Decoding:

1. Scan the ENTER/EXIT Programming Mode bar code.
2. Scan the Fixed Length Decoding bar code.
3. Scan the ENTER/EXIT Programming Mode bar code.
4. Set Length 1 to the first fixed length using the [Micro PDF 417 Length 1, Length 2 Programming Instructions on page 252](#) that follow this page.
5. Set Length 2 to the second fixed length (or to '0000' if there is only one fixed length) using the [Micro PDF 417 Length 1, Length 2 Programming Instructions on page 252](#).

**Configuring Variable Length Decoding:**

1. Scan the ENTER/EXIT Programming Mode bar code.
2. Scan the Variable Length Decoding bar code.
3. Scan the ENTER/EXIT Programming Mode bar code.
4. Set Length 1 to the minimum length using the [Micro PDF 417 Length 1, Length 2 Programming Instructions on page 252](#) that follow this page.
5. Set Length 2 to the maximum length using the [Micro PDF 417 Length 1, Length 2 Programming Instructions on page 252](#).

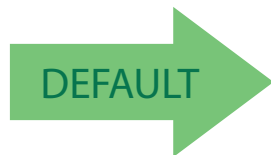

Micro PDF 417 Length Control = Variable Length



Micro PDF 417 Length Control = Fixed Length

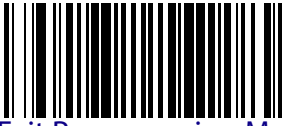

### Micro PDF 417 Length 1, Length 2 Programming Instructions

If Micro PDF 417 Length Control is set to Fixed–Length decoding, this feature specifies Micro PDF 417 first fixed length. If Micro PDF 417 Length Control is set to Variable–Length decoding, this feature specifies the minimum label length.



**NOTE**

This tag is only valid for units with a model ID that supports PDF. Length 1 is the minimum label length if in variable length mode, or the first fixed length if in fixed length mode. Length 2 is the maximum label length if in variable length mode, or the second fixed length if in fixed length mode. Length includes the bar code's data characters only. Any value > 0366 will be considered to be 0366.

To set this feature:

1. Scan the ENTER/EXIT Programming Mode bar code.
2. Scan the bar code, [Set Micro PDF 417 Length 1 on page 252](#) or [Set Micro PDF 417 Length 2 on page 252](#) below. You'll need to cover any unused bar codes on this and the facing page to ensure that the scanner reads only the bar code you intend to scan.
3. Scan the appropriate digits from the [Alpha–Numeric Keypad in Appendix C](#) that represent the desired label length. The selectable range for this option is 0001 to 0366. Pad all numbers with leading zeros to yield a four–digit entry (0001–0366).
4. Complete the programming sequence by scanning the ENTER/EXIT Programming Mode bar code.



Set Micro PDF 417 Length 1  
Default setting for this feature = 0001



Set Micro PDF 417 Length 2  
Default setting for this feature = 016E (length = 366)

## Micro PDF 417 128 Emulation

This feature specifies which AIM ID to use for Micro PDF 417 labels when performing Code 128 or EAN 128 emulation.

To set this feature:

1. Scan the Enter/Exit Programming Mode bar code.
2. Scan the bar code below for the desired setting. You'll need to cover any unused bar codes on this and the facing page to ensure that the scanner reads only the bar code you intend to scan.
3. Complete the programming sequence by scanning the Enter/Exit Programming Mode bar code.

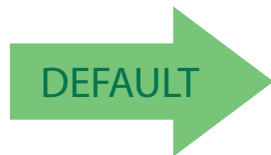

Micro PDF 417 128 Emulation = Micro PDF AIM ID and label type when emulating EAN128 or Code 128



Micro PDF 417 128 Emulation = Code 128 / EAN128 AIM ID and label type when emulating EAN128 or Code 128

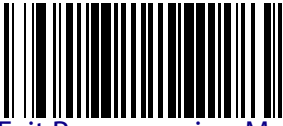

## QR Code

### QR Code Enable

Enables/disables the ability of the scanner to decode QR Code labels.

To set this feature:

1. Scan the Enter/Exit Programming Mode bar code.
2. Scan either the enable or disable bar code below. You'll need to cover any unused bar codes on this and the facing page to ensure that the scanner reads only the bar code you intend to scan.
3. Complete the programming sequence by scanning the Enter/Exit Programming Mode bar code.

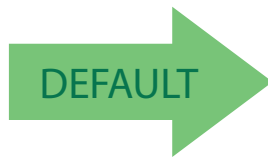

QR Code = Disable



QR Code = Enable



## QR Code Length Control

**Fixed Length Decoding** — When fixed length decoding is enabled, the scanner will decode a bar code if the label length matches one of the configurable fixed lengths.

**Variable Length Decoding** — When variable length decoding is enabled, the scanner will decode a bar code if the label length falls in the range of the configurable minimum and maximum length.

Configuring Fixed Length Decoding:

1. Scan the ENTER/EXIT Programming Mode bar code.
2. Scan the Fixed Length Decoding bar code.
3. Scan the ENTER/EXIT Programming Mode bar code.
4. Set Length 1 to the first fixed length using the [QR Code Length 1, Length 2 Programming Instructions on page 256](#) that follow this page.
5. Set Length 2 to the second fixed length (or to '0000' if there is only one fixed length) using the [QR Code Length 1, Length 2 Programming Instructions on page 256](#).

Configuring Variable Length Decoding:

1. Scan the ENTER/EXIT Programming Mode bar code.
2. Scan the Variable Length Decoding bar code.
3. Scan the ENTER/EXIT Programming Mode bar code.
4. Set Length 1 to the minimum length using the [QR Code Length 1, Length 2 Programming Instructions on page 256](#) that follow this page.
5. Set Length 2 to the maximum length using the [QR Code Length 1, Length 2 Programming Instructions on page 256](#).

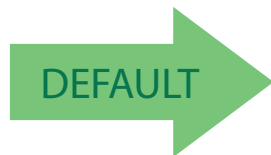

QR Code Length Control = Variable Length



QR Code Length Control = Fixed Length

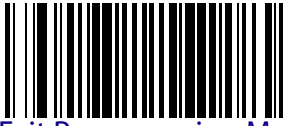

### QR Code Length 1, Length 2 Programming Instructions

If QR Code Length Control is set to Fixed–Length decoding, this feature specifies QR Code first fixed length. If QR Code Length Control is set to Variable–Length decoding, this feature specifies the minimum label length.



**NOTE**

**Length 1 is the minimum label length if in variable length mode, or the first fixed length if in fixed length mode. Length 2 is the maximum label length if in variable length mode, or the second fixed length if in fixed length mode. Length includes the bar code's data characters only. Any value > 2710 will be considered to be 2710.**

To set this feature:

1. Scan the ENTER/EXIT Programming Mode bar code.
2. Scan the bar code, [Set QR Code Length 1 on page 256](#) or [Set QR Code Length 2 on page 256](#) below. You'll need to cover any unused bar codes on this and the facing page to ensure that the scanner reads only the bar code you intend to scan.
3. Scan the appropriate digits from the [Alpha–Numeric Keypad in Appendix C](#) that represent the desired label length. The selectable range for this option is 0001 to 2710. Pad all numbers with leading zeros to yield a four–digit entry (001–02710).
4. Complete the programming sequence by scanning the ENTER/EXIT Programming Mode bar code.



Set QR Code Length 1  
Default setting for this feature = 0001



Set QR Code Length 2  
Default setting for this feature = 0A96 (length = 2710)

## QR Code URL Link Enable

Enables/Disables the decoding of QR codes with a URL link on imagers other than the optional Customer Service Scanner (CSS).

To set this feature:

1. Scan the Enter/Exit Programming Mode bar code.
2. Scan either the enable or disable bar code below. You'll need to cover any unused bar codes on this and the facing page to ensure that the scanner reads only the bar code you intend to scan.
3. Complete the programming sequence by scanning the Enter/Exit Programming Mode bar code.

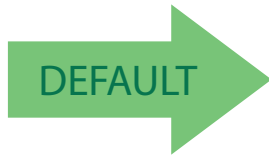

QR Code URL Link = Disable



QR Code URL Link = Enable

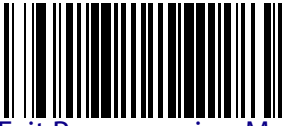

## GS1 QR Code Enable

This feature controls the ability of the scanner to decode GS1 QR Code labels.

To set this feature:

1. Scan the Enter/Exit Programming Mode bar code.
2. Scan either the enable or disable bar code below. You'll need to cover any unused bar codes on this and the facing page to ensure that the scanner reads only the bar code you intend to scan.
3. Complete the programming sequence by scanning the Enter/Exit Programming Mode bar code.

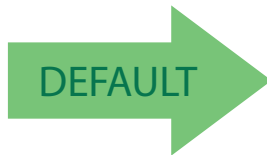

GS1 QR Code = Disable



GS1 QR Code = Enable

## Micro QR Code

### Micro QR Code Enable

Enables/disables the ability of the scanner to decode Micro QRCode labels.  
To set this feature:

1. Scan the Enter/Exit Programming Mode bar code.
2. Scan either the enable or disable bar code below. You'll need to cover any unused bar codes on this and the facing page to ensure that the scanner reads only the bar code you intend to scan.
3. Complete the programming sequence by scanning the Enter/Exit Programming Mode bar code.

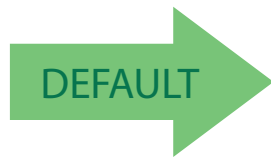

Micro QR Code = Disable



Micro QR Code = Enable



## Micro QR Code Length Control

**Fixed Length Decoding** — When fixed length decoding is enabled, the scanner will decode a bar code if the label length matches one of the configurable fixed lengths.

**Variable Length Decoding** — When variable length decoding is enabled, the scanner will decode a bar code if the label length falls in the range of the configurable minimum and maximum length.

Configuring Fixed Length Decoding:

1. Scan the ENTER/EXIT Programming Mode bar code.
2. Scan the Fixed Length Decoding bar code.
3. Scan the ENTER/EXIT Programming Mode bar code.
4. Set Length 1 to the first fixed length using the [Micro QR Code Length 1, Length 2 Programming Instructions on page 261](#) that follow this page.
5. Set Length 2 to the second fixed length (or to '0000' if there is only one fixed length) using the [Micro QR Code Length 1, Length 2 Programming Instructions on page 261](#).

Configuring Variable Length Decoding:

1. Scan the ENTER/EXIT Programming Mode bar code.
2. Scan the Variable Length Decoding bar code.
3. Scan the ENTER/EXIT Programming Mode bar code.
4. Set Length 1 to the minimum length using the [Micro QR Code Length 1, Length 2 Programming Instructions on page 261](#) that follow this page.
5. Set Length 2 to the maximum length using the [Micro QR Code Length 1, Length 2 Programming Instructions on page 261](#).



Micro QR Code Length Control = Variable Length



Micro QR Code Length Control = Fixed Length

## Micro QR Code Length 1, Length 2 Programming Instructions

If Micro QR Code Length Control is set to Fixed–Length decoding, this feature specifies Micro QR Code first fixed length. If Micro QR Code Length Control is set to Variable–Length decoding, this feature specifies the minimum label length.



### NOTE

**Length 1** is the minimum label length if in variable length mode, or the first fixed length if in fixed length mode. **Length 2** is the maximum label length if in variable length mode, or the second fixed length if in fixed length mode. Length includes the bar code's data characters only. Any value > 3700 will be considered to be 3700.

To set this feature:

1. Scan the ENTER/EXIT Programming Mode bar code.
2. Scan the bar code, [Set Aztec Length 1 on page 264](#) or [Set Micro QR Code Length 2 on page 261](#) below. You'll need to cover any unused bar codes on this and the facing page to ensure that the scanner reads only the bar code you intend to scan.
3. Scan the appropriate digits from the [Alpha–Numeric Keypad in Appendix C](#) that represent the desired label length. The selectable range for this option is 0001 to 3700. Pad all numbers with leading zeros to yield a four–digit entry (0001–3700).
4. Complete the programming sequence by scanning the ENTER/EXIT Programming Mode bar code.



Set Micro QR Code Length 1  
Default setting for this feature = 0001



Set Micro QR Code Length 2  
Default setting for this feature = 0E74 (length = 3700)



## Aztec Code

### Aztec Enable

Enables/disables the ability of the scanner to decode Aztec labels.

To set this feature:

1. Scan the Enter/Exit Programming Mode bar code.
2. Scan either the enable or disable bar code below. You'll need to cover any unused bar codes on this and the facing page to ensure that the scanner reads only the bar code you intend to scan.
3. Complete the programming sequence by scanning the Enter/Exit Programming Mode bar code.

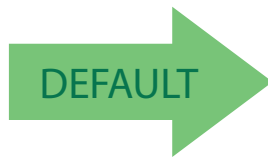

Aztec = Disable



Aztec = Enable



## Aztec Length Control

**Fixed Length Decoding** — When fixed length decoding is enabled, the scanner will decode a bar code if the label length matches one of the configurable fixed lengths.

**Variable Length Decoding** — When variable length decoding is enabled, the scanner will decode a bar code if the label length falls in the range of the configurable minimum and maximum length.

Configuring Fixed Length Decoding:

1. Scan the ENTER/EXIT Programming Mode bar code.
2. Scan the Fixed Length Decoding bar code.
3. Scan the ENTER/EXIT Programming Mode bar code.
4. Set Length 1 to the first fixed length using the [Aztec Length 1, Length 2 Programming Instructions on page 264](#) that follow this page.
5. Set Length 2 to the second fixed length (or to '0000' if there is only one fixed length) using the [Aztec Length 1, Length 2 Programming Instructions on page 264](#).

Configuring Variable Length Decoding:

1. Scan the ENTER/EXIT Programming Mode bar code.
2. Scan the Variable Length Decoding bar code.
3. Scan the ENTER/EXIT Programming Mode bar code.
4. Set Length 1 to the minimum length using the [Aztec Length 1, Length 2 Programming Instructions on page 264](#) that follow this page.
5. Set Length 2 to the maximum length using the [Aztec Length 1, Length 2 Programming Instructions on page 264](#).

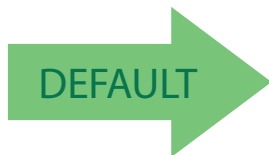

Aztec Length Control = Variable Length



Aztec Length Control = Fixed Length



### Aztec Length 1, Length 2 Programming Instructions

If Aztec Length Control is set to Fixed–Length decoding, this feature specifies Aztec first fixed length. If Aztec Length Control is set to Variable–Length decoding, this feature specifies the minimum label length.



**NOTE**

**Length 1 is the minimum label length if in variable length mode, or the first fixed length if in fixed length mode. Length 2 is the maximum label length if in variable length mode, or the second fixed length if in fixed length mode. Length includes the bar code's data characters only. Any value > 3700 will be considered to be 3700.**

To set this feature:

1. Scan the ENTER/EXIT Programming Mode bar code.
2. Scan the bar code, [Set Aztec Length 1 on page 264](#) or [Set Aztec Length 2 on page 264](#) below. You'll need to cover any unused bar codes on this and the facing page to ensure that the scanner reads only the bar code you intend to scan.
3. Scan the appropriate digits from the [Alpha–Numeric Keypad in Appendix C](#) that represent the desired label length. The selectable range for this option is 0001 to 3700. Pad all numbers with leading zeros to yield a four–digit entry (0001–3700).
4. Complete the programming sequence by scanning the ENTER/EXIT Programming Mode bar code.



Set Aztec Length 1  
Default setting for this feature = 0001



Set Aztec Length 2  
Default setting for this feature = 0E74 (length = 3700)



## Chapter 3 References

This section contains explanations and examples of selected bar code features. See the programming sections for the actual bar code labels used to configure the reader.

### Global Prefix/Suffix

Up to 20 ASCII characters may be added as a prefix (in a position before the bar code data) and/or as a suffix (in a position following the bar code data) as indicated in Figure 7.

Figure 7. Prefix and Suffix Positions

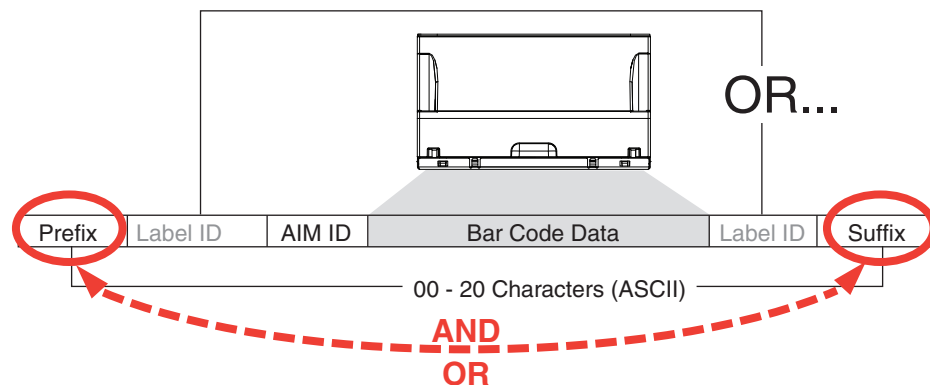

#### Example: Setting a Prefix

In this example, we'll set a prefix for all symbologies.

1. Determine which ASCII character(s) are to be added to scanned bar code data. In this example, we'll add a dollar sign ('\$') as a prefix.
2. Scan the Enter/Exit Programming Mode bar code.
3. Scan the SET PREFIX bar code.
4. Reference the [ASCII Character Set on page i](#) on the inside back cover of this manual, to find the hex value assigned to the desired character. The corresponding hex number for the '\$' character is 24. To enter this selection code, scan the '2' and '4' bar codes from [Appendix C, Alpha-Numeric Keypad](#).

5. Scan the END bar code once to finish the string, then scan END again to exit Programming Mode.

**NOTE**

If all 20 characters will be used in the prefix or suffix, do not scan the END bar code to finish the string. It is done automatically.

6. The resulting message string would appear as follows:

Scanned bar code data: 12345

Resulting message string output: \$12345

## Label ID

A Label ID is used to identify a bar code (symbology) type. See [Appendix D, Factory Default Settings](#), for a listing for common symbologies. It can be appended previous to or following the transmitted bar code data depending upon how this option is enabled. This feature provides options for configuring custom Label IDs individually per symbology. If you wish to program the scanner to always include an industry standard label identifier for ALL symbology types, see the feature, [AIM ID](#) on page 2–87.

The Label ID is a customizable code of up to three ASCII characters (each of which are 00–7F) followed by a control character (00–01). This control character, when set to zero, does nothing. When set to one, it appends the symbology's AIM ID to the Label ID.

**NOTE**

When the control character is set to 01 for UPC-A and UPC-E, it expands the label to EAN-13 and thus follows the EAN-13 Label ID settings.

To configure a Label ID:

1. Scan the Enter/Exit Programming Mode bar code.
2. Select Label ID position as either BEFORE or AFTER by scanning the appropriate bar code.
3. Scan a bar code to select the symbology for which you wish to configure a custom Label ID.
4. Determine the desired character(s) (you may choose up to three) which will represent the Label ID for the selected symbology. Next, turn to the [ASCII Character Set on page i](#) on the inside back cover of this manual and find the equivalent hex digits associated with your choice of Label ID. For example, if you wish to select an equal sign (=) as a Label ID, the chart indicates its associated hex characters as 3D.
5. Turn to [Appendix C](#) and scan the bar codes representing the hex characters determined in the previous step. For example, to make an equal sign (=), scan '3' and 'D' followed by '0' six times. Since this is a three-character buffer, '00' is scanned for character two, '00' for character three and '00' for the control character. ('00' indicates no character.)

- Scan the END bar code to exit programming mode.

**Figure 8. Label ID Position Options**

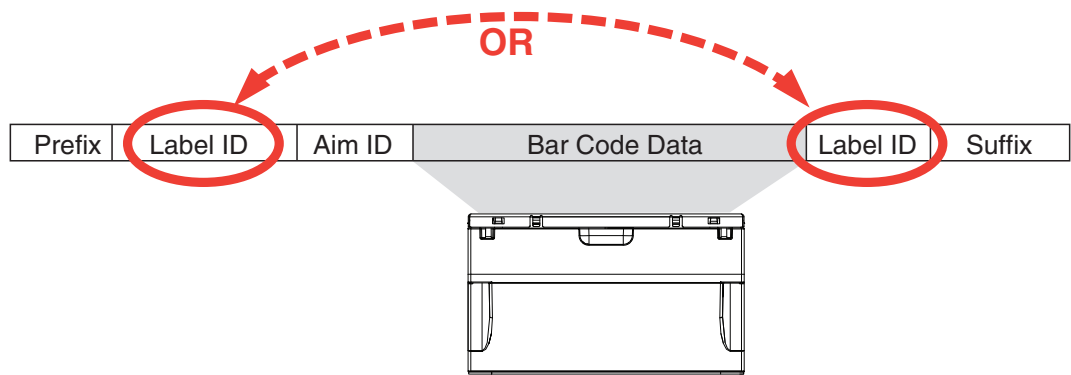

## Length Control

**Fixed Length Decoding** — When fixed length decoding is enabled, the scanner will decode a bar code if the label length matches one of the configurable fixed lengths.

**Variable Length Decoding** — When variable length decoding is enabled, the scanner will decode a bar code if the label length falls in the range of the configurable minimum and maximum length.

Configuring Fixed Length Decoding:

- Scan the Enter/Exit Programming Mode bar code.
- Scan the Fixed Length Decoding bar code for the desired symbology.
- Scan the Enter/Exit Programming Mode bar code.
- Set Length 1 to the first fixed length by following the [Length 1, Length 2 Programming Instructions](#) below.
- Set Length 2 to the second fixed length (or to '00' if there is only one fixed length) by following the [Length 1, Length 2 Programming Instructions](#) below.

## Configuring Variable Length Decoding:

1. Scan the Enter/Exit Programming Mode bar code.
2. Scan the Variable Length Decoding bar code for the desired symbology.
3. Scan the Enter/Exit Programming Mode bar code.
4. Set Length 1 to the first variable length by following the [Length 1, Length 2 Programming Instructions](#) below.
5. Set Length 2 to the second variable length by following the [Length 1, Length 2 Programming Instructions](#) below.

## Length 1, Length 2 Programming Instructions

1. Scan the Enter/Exit Programming Mode bar code.
2. Scan either the Set Length 1 or Set Length 2 bar code for the desired symbology.
3. Turn to [Appendix C](#) and scan the two digits (zero padded) representing the length in decimal notation. The number of characters that can be set varies, depending upon the symbology. Reference the page for your selected symbology to see specific variables.
4. Scan the Enter/Exit Programming Mode bar code.



# Appendix A

## Product Specifications

### Decoding Capability

Parameter	Specification
1D / Linear Codes	Autodiscriminates All Standard 1D Codes Including GS1 Databar™ Linear Codes.
2D Codes	Aztec Code; Data Matrix (ECC200 Only); QR Code
Stacked Codes	GS1 Databar Composites; GS1 Databar Expanded Stacked; GS1 Databar Stacked; GS1 Databar Stacked Omnidirectional; Micro-PDF417; PDF417
Digital Watermarks	Optional Support For Digimarc® Barcodes/GS1 DW Code

### Electrical

Parameter	Specification
AC Power Requirements	AC Input: 100-240 VAC, 50-60 Hz; DC Input: 5-12 V
Power Consumption	Operating (Maximum): 4.0 Watts; Operating (nominal): 3.0 Watts Sleep Mode: 2.8 Watts

## Environmental

Parameter	Specification
Ambient Light	0 - 86,100 lux
ESD Protection (Air Discharge)	25 kV
Humidity (Non-condensing)	5 - 95%
Particulate And Water Sealing	IP52
Temperature	Operating: 0 to 40 °C / 32 to 104 °F Storage/transport: -40 to 70 °C / -40 to 158 °F

## Interfaces

Parameter	Specification
Interfaces	OEM (IBM) USB; RS-232; USB Keyboard; USB COM Powered Type A USB (USB Com)

## Optional Features

Parameter	Specification
EAS Features	Good Read signal available for use with various EAS hardware, such as Checkpoint Systems and Sensormatic devices.
Value Added Features	Diagnostic Reporting; Host Download; Magellan ULE Scripting



# Physical Characteristics

Parameter	Specification
Dimensions	Magellan Model 3550HSi
Depth (Below counter)	8.7 cm / 3.4 in
Length	15.2 cm / 6.0 in
Width	15.2 cm / 6.0 in
Weight	0.98 kg / 2.16 lb

## Scanner Dimensions

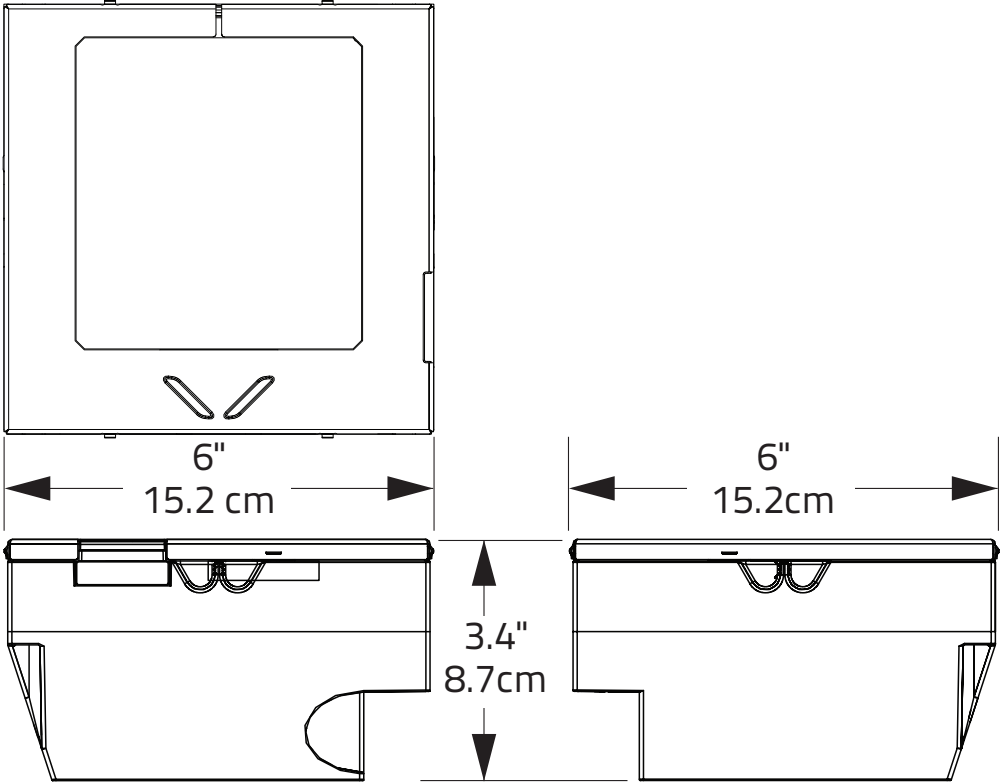

## Reading Performance

Parameter	Specification
Image Capture	Graphic Formats: BMP, JPEG
Imager Sensor	1280 X 1024
Light Source	Multiple Diffused LEDS, Orientation and Wavelength Optimized for Eye Comfort
Print Contrast Ratio (Minimum)	25%
Read Height	10.2 cm / 4.0 in
Read Rate (Maximum)	39 Million Pixels per Second
Reading Indicators	Audio Speaker w/Adjustable Tone and Volume, Supports .wav Files; Good Read LED; Good Transmission
Resolution (Maximum)	5 Mil

## Safety & Regulatory

Parameter	Specification
Agency Approvals	The product meets necessary safety and regulatory approvals for its intended use.
Environmental Compliance	Complies to China RoHS; Complies to EU RoHS
LED Classification	EN62471 and IEC62471 Lamp Illumination - Exempt Group

## Utilities

Parameter	Specification
Scanalyzer	Magellan Scanalyzer Configuration Software is available for download at no charge.
OPOS / JavaPOS	JavaPOS Utilities are available for download at no charge. OPOS Utilities are available for download at no charge.

## Warranty

Warranty	3-year Factory Warranty
----------	-------------------------

## LED and Beeper Indicators

The scanner's beeper sounds and its green LED illuminates to indicate various functions or errors on the scanner. The tables below list these indications. The scanner's functions are programmable, and so may or may not be turned on. For example, certain indications, such as the power-up beep can be disabled using programming bar code labels.

LED INDICATION	INDICATION	COMMENT
Power-on indication	Bright green flash	Indicates the scanner has finished all its power up tests and is now ready for operation.
Good Read Indication	Bright green flash	Indicates a bar code has been read and decoded.
Scanner Ready	Constant dim green	The scanner is ready for operation. The LED is also configurable to off when idle and ready for operation
Sleep Mode	Green LED slowly and continuously changes from off to dim to off.	The scanner is in Sleep Mode. To wake the scanner up, move an object in front of its window or press the button atop the unit. This indication is configurable and may be programmed to behave differently.
Host Disable	Constant green flash at 1 Hz (100mS on, 900mS off)	The scanner is disabled due to receiving a disable command from the POS terminal.
Diagnostics	Varies (see Error Codes on page 274 for more information)	The LED can provide diagnostic feedback if the scanner discovers a problem during SelfTest.
Prog. Mode	See Host Disable above.	The scanner is in Programming Mode.

### BEEPER FUNCTIONS

BEEPER INDICATION	INDICATION	COMMENT
Power On Beep	Single beep	The Power-On Beep indication is a configurable feature which can be enabled or disabled. When enabled, this beep Indicates the scanner has finished all its power up tests and is now ready for operation.
Good Read Indication	Single beep	The good read beep indication is configurable. Options include: Enable/disable, frequency, duration and volume. See <a href="#">LED and Beeper Indicators</a> on page 2-57 for more information.
Diagnostics	Varies (see <a href="#">"Error Codes"</a> for more information)	The Beeper can provide diagnostic feedback if the scanner discovers a problem during SelfTest.
Programming Mode Indications	Varies depending upon the feature(s) being configured.	The Beeper will sound as programming bar code labels are scanned, indicating progress during scanner configuration.

## Error Codes

If an error is detected, the scanner will sound a long low tone (for three seconds) and flash its LED, indicating a failure. When this occurs, press the Scanner Pushbutton to hear the error code. If it is configured to do so, the scanner will sound a series of beeps corresponding to the error code and/or flash its LED simultaneous to the beeps. The table below describes what these codes mean and what action should be taken for each.

<b>NUMBER OF LED FLASHES/ BEEPS</b>	<b>ERROR</b>	<b>CORRECTIVE ACTION</b>
1	Configuration	Contact Helpdesk for assistance
2	Interface PCB	
6	Main PCB	
10	Button Error	
12	Imager Module	
13	Software ID Failure	
14	Software Fatal Fault	



## Appendix B Cable Pinouts

### Standard Cable Pinouts (Primary Interface Cables)

Pin #	RS-232	USB-OEM	USB, USB Keyboard, USB COM
1		D+	D+
2	CTS		
3		D-	D-
4	RTS		
5	RxD		
6	TxD		
7			
8	Vin	Vin/VBUS	Vin/VBUS
9	GND	GND	GND
10	ERI	ERI	ERI



## Appendix C Alpha-Numeric Keypad





1



**NOTE**

For numeric entry sequences, the scanner will announce the number of digits remaining to be entered after each label read.



2



3



4



5



6



7



8



9



0



# Appendix D

## Factory Default Settings

The following table provides a listing of the most common factory settings for the interfaces shown.



**NOTE**

Some of the individual interfaces listed in the defaults table below appear in the same column since they share similar feature settings with few (if any) exceptions.

Keep in mind though, that the actual configuration storage area for each interface is unique and that updates & changes to factory defaults can be made at any time without notice.

### Factory Default Settings

Feature	Default Master	RS-232	RS-232 Wincor- Nixdorf	Keyboard	USB COM / USB TEC	USB OEM
<b>General Scanner Features</b>						
1D Double Read Timeout on page 10	28 (400ms)	28 (400ms)	28 (400ms)	28 (400ms)	28 (400ms)	28 (400ms)
2D Double Read Timeout on page 11	46 (700ms)	46 (700ms)	46 (700ms)	46 (700ms)	46 (700ms)	46 (700ms)
Digital Watermark (Digimarc) Enable on page 12	01 (enable)	01 (enable)	01 (enable)	01 (enable)	01 (enable)	01 (enable)
Digital Watermark (Digimarc) Double Read Timeout on page 13	0.5 Sec.	0.5 Sec.	0.5 Sec.	0.5 Sec.	0.5 Sec.	0.5 Sec.
Digital Watermark (Digimarc) Data Format on page 14	00 (compatibility mode)	00 (compatibility mode)	00 (compatibility mode)	00 (compatibility mode)	00 (compatibility mode)	00 (compatibility mode)
Sleep Mode Timer on page 15	5 minutes	5 minutes	5 minutes	5 minutes	5 minutes	5 minutes
1D Inverse Read Control on page 16	00 (disable)	00 (disable)	00 (disable)	00 (disable)	00 (disable)	00 (disable)
2D Inverse Read Control on page 17	00 (disable)	00 (disable)	00 (disable)	00 (disable)	00 (disable)	00 (disable)



Feature	Default Master	RS-232	RS-232 Wincor- Nixdorf	Keyboard	USB COM / USB TEC	USB OEM
Illumination During Disable Mode on page 20	01 (enable)	01 (enable)	01 (enable)	01 (enable)	01 (enable)	01 (enable)
Object Sense Control on page 21	40 (enable)	40 (enable)	40 (enable)	40 (enable)	40 (enable)	40 (enable)
Reading Illumination Duration on page 18	64 (5 sec)	64 (5 sec)	64 (5 sec)	64 (5 sec)	64 (5 sec)	64 (5 sec)
Good Read LED Idle State on page 25	02 (on dim)	02 (on dim)	02 (on dim)	02 (on dim)	02 (on dim)	02 (on dim)
Scanner Control Button Options on page 26	01	01	01	01	01	01
Good Read Beep Control on page 27	01 (1 beep)	01 (1 beep)	01 (1 beep)	01 (1 beep)	01 (1 beep)	01 (1 beep)
Good Read Beep Control on page 27	01 (enable)	01 (enable)	01 (enable)	01 (enable)	01 (enable)	01 (enable)
Good Read Beep Frequency on page 28	01 (med.)	01 (med.)	01 (med.)	01 (med.)	01 (med.)	01 (med.)
Good Read Beep Length on page 29	008 (80ms)	008 (80ms)	008 (80ms)	008 (80ms)	008 (80ms)	008 (80ms)
Good Read Beep Volume on page 30	02 (med)	02 (med)	02 (med)	02 (med)	02 (med)	02 (med)
Good Read When to Indicate on page 31	00 (after decode)	00 (after decode)	00 (after decode)	00 (after decode)	00 (after decode)	00 (after decode)
Handheld Host Download Timeout on page 32	0F (15 seconds)	0F (15 seconds)	0F (15 seconds)	0F (15 seconds)	0F (15 seconds)	0F (15 seconds)
<b>Imaging Features</b>						
Cell Phone Mode on page 35	02 (Enable)	02 (Enable)	02 (Enable)	02 (Enable)	02 (Enable)	02 (Enable)
Cell Mode Percent on page 36	00 (Very Low)	00 (Very Low)	00 (Very Low)	00 (Very Low)	00 (Very Low)	00 (Very Low)
Picture Retrieval Timeout on page 37	05 (5 sec.)	05 (5 sec.)	05 (5 sec.)		05 (5 sec.)	05 (5 sec.)
Image Capture Delay on page 39	05 (5 sec.)	05 (5 sec.)	05 (5 sec.)	05 (5 sec.)	05 (5 sec.)	05 (5 sec.)
Image Format on page 40	00 (JPG)	00 (JPG)	00 (JPG)	00 (JPG)	00 (JPG)	00 (JPG)
Image Size on page 41	00 (VGA)	00 (VGA)	00 (VGA)	00 (VGA)	00 (VGA)	00 (VGA)

Feature	Default Master	RS-232	RS-232 Wincor- Nixdorf	Keyboard	USB COM / USB TEC	USB OEM
Image Brightness on page 42	Level 0	Level 0	Level 0	Level 0	Level 0	Level 0
Image Contrast on page 44	Level 0	Level 0	Level 0	Level 0	Level 0	Level 0
Image Compression on page 46	64 (Compression = 100)	64 (Compression = 100)	64 (Compression = 100)	64 (Compression = 100)	64 (Compression = 100)	64 (Compression = 100)
Region of Interest (ROI) on page 47	000004FF00003FF (full size)	000004FF00003FF (full size)	000004FF00003FF (full size)	000004FF00003FF (full size)	000004FF00003FF (full size)	000004FF00003FF (full size)
<b>Interface Related Features</b>						
Maximum Host-Transmitted Message Length on page 54	000 (no gen. limit imposed)	000 (no gen. limit imposed)	000 (no gen. limit imposed)	000 (no gen. limit imposed)	000 (no gen. limit imposed)	000 (no gen. limit imposed)
RS-232 Baud Rate on page 55	01 (9600)	01 (9600)	01 (9600)		01 (9600)	
RS-232 Number of Data Bits on page 57	01 (8 data bits)	01 (8 data bits)	01 (8 data bits)		01 (8 data bits)	
RS-232 Number of Stop Bits on page 57	00 (1 stop bit)	00 (1 stop bit)	00 (1 stop bit)		00 (1 stop bit)	
RS-232 Parity on page 58	00 (none)	00 (none)	02 (odd)		00 (none)	
RS-232 Hardware Control on page 59	00 (disable)	00 (disable)	01 (enable CTS flow control)		00 (disable)	
RS-232 Intercharacter Delay on page 60	00 (no delay)	00 (no delay)	00 (no delay)		00 (no delay)	
RS-232 Software Flow Control on page 61	00 (disable)	00 (disable)	00 (disable)		00 (disable)	
RS-232 Beep on ASCII BEL on page 62	00 (disable)	00 (disable)	00 (disable)		00 (disable)	
Beep on Not on File on page 62	01 (low vol)	01 (low vol)	01 (low vol)		01 (low vol)	01 (low vol)
ACK NAK Enable on page 63	00 (disable)	00 (disable)	00 (disable)		00 (disable)	
RS-232 ACK Character on page 64	06 (ACK)	06 (ACK)	06 (ACK)		06 (ACK)	
RS-232 NAK Character on page 65	15 (NAK)	15 (NAK)	15 (NAK)		15 (NAK)	

Feature	Default Master	RS-232	RS-232 Wincor- Nixdorf	Keyboard	USB COM / USB TEC	USB OEM
RS-232 Retry on ACK NAK Timeout on page 66	01 (enable)	01 (enable)	01 (enable)		01 (enable)	
RS-232 ACK NAK Timeout Value on page 67	01 (200ms)	01 (200ms)	01 (200ms)		01 (200ms)	
RS-232 ACK NAK Retry Count on page 68	03 (3 retries)	03 (3 retries)	03 (3 retries)		03 (3 retries)	
RS-232 ACK NAK Error Handling on page 69	00 (ignore)	00 (ignore)	00 (ignore)		00 (ignore)	
RS-232 Indicate Transmission Failure on page 70	01 (enable)	01 (enable)	01 (enable)		01 (enable)	
RS-232 Ignore Host Commands on page 71	00	00	00	00	00	00
USB-OEM Interface Features on page 72	02	02	02	02	02	01
USB OEM Scanner Device Type on page 72	00 (table top)					00 (table top)
USB OEM Additional Interface Options on page 73	00 (disabled upon enumeration)					00 (disabled upon enumeration)
USB Keyboard Country Mode on page 74	00 (USA)			00 (USA)		
USB Keyboard Caps Lock State on page 77	00 (caps lock OFF)			00 (caps lock OFF)		
No Keyboard Support on page 78	00 (disable)			00 (disable)		
USB Keyboard Send Control Characters on page 79	00 (disable)			00 (disable)		
Quiet Interval on page 80	0A (100ms)			0A (100ms)		
USB Keyboard Inter-character Delay on page 81	01 (10ms)			01 (10ms)		
<b>Data Editing</b>						
Global Prefix on page 85	00 (no prefix)	00 (no prefix)	00 (no prefix)	00 (no prefix)	00 (no prefix)	00 (no prefix)
Global Suffix on page 86	0D00 (CR)	0D00 (CR)	0D00 (CR)	0D00 (CR)	0D00 (CR)	0D00 (CR)

Feature	Default Master	RS-232	RS-232 Wincor- Nixdorf	Keyboard	USB COM / USB TEC	USB OEM
AIM ID on page 87	00 (disable)	00 (disable)	00 (disable)	00 (disable)	00 (disable)	
Label ID on page 88	01 (Enable as prefix)	01 (Enable as prefix)	01 (Enable as prefix)	01 (Enable as prefix)	01 (Enable as prefix)	
Global Mid-Label ID on page 96	00 (no mid-label ID)	00 (no mid-label ID)	00 (no mid-label ID)	00 (no mid-label ID)	00 (no mid-label ID)	
Case Conversion on page 97	00 (no case convers'n)	00 (no case convers'n)	00 (no case convers'n)	00 (no case convers'n)	00 (no case convers'n)	00 (no case convers'n)
Character Conversion on page 98	FFFFFFFF FFFFFF (no char. convers'n)	FFFFFFFF FFFFFF (no char. convers'n)	FFFFFFFF FFFFFF (no char. convers'n)	FFFFFFFF FFFFFF (no char. convers'n)	FFFFFFFF FFFFFF (no char. convers'n)	FFFFFFFF FFFFFF (no char. convers'n)
<b>1D Symbology Programming</b>						
Coupon Control Enable on page 100	01 (enable UPC-A)	03 (UPC-A coupon priority)	03 (UPC-A coupon priority)	03 (UPC-A coupon priority)	03 (UPC-A coupon priority)	03 (UPC-A coupon priority)
Coupon Label Priority Timer on page 101	0.2 Sec.	0.2 Sec.	0.2 Sec.	0.2 Sec.	0.2 Sec.	0.2 Sec.
UPC-A Enable on page 102	01 (enable)	01 (enable)	01 (enable)	01 (enable)	01 (enable)	01 (enable)
UPC-A Number System Character Transmission on page 103	01 (enable)	01 (enable)	01 (enable)	01 (enable)	01 (enable)	01 (enable)
UPC-A Check Character Transmission on page 104	01 (enable)	01 (enable)	01 (enable)	01 (enable)	01 (enable)	01 (enable)
UPC-A Minimum Read on page 105	01 (1 read)	01 (1 read)	01 (1 read)	01 (1 read)	01 (1 read)	01 (1 read)
Expand UPC-A to EAN-13 on page 106	00 (disable)	00 (disable)	01 (enable)	00 (disable)	00 (disable)	00 (disable)
UPC-E Enable on page 107	01 (enable)	01 (enable)	01 (enable)	01 (enable)	01 (enable)	01 (enable)
UPC-E Number System Character Transmission on page 108	01 (enable)	01 (enable)	01 (enable)	01 (enable)	01 (enable)	01 (enable)
UPC-E Check Character Transmission on page 109	01 (enable)	01 (enable)	00 (disable)	01 (enable)	01 (enable)	01 (enable)
Expand UPC-E to UPC-A on page 110	00 (disable)	00 (disable)	00 (disable)	00 (disable)	00 (disable)	00 (disable)

Feature	Default Master	RS-232	RS-232 Wincor- Nixdorf	Keyboard	USB COM / USB TEC	USB OEM
<a href="#">Expand UPC-E to EAN-13 on page 111</a>	00 (disable)	00 (disable)	00 (disable)	00 (disable)	00 (disable)	00 (disable)
<a href="#">UPC-E Minimum Read on page 112</a>	01 (1 read)	01 (1 read)	01 (1 read)	01 (1 read)	01 (1 read)	01 (1 read)
<a href="#">EAN-13 on page 113</a>	01 (enable)	01 (enable)	01 (enable)	01 (enable)	01 (enable)	01 (enable)
<a href="#">EAN-13 First Character Transmission on page 114</a>	01 (enable)	01 (enable)	01 (enable)	01 (enable)	01 (enable)	01 (enable)
<a href="#">EAN-13 Check Character Transmission on page 115</a>	01 (enable)	01 (enable)	01 (enable)	01 (enable)	01 (enable)	01 (enable)
<a href="#">EAN-13 ISBN Conversion Enable on page 116</a>	00 (disable)	00 (disable)	00 (disable)	00 (disable)	00 (disable)	00 (disable)
<a href="#">EAN-13 Minimum Read on page 117</a>	01 (1 read)	01 (1 read)	01 (1 read)	01 (1 read)	01 (1 read)	01 (1 read)
<a href="#">EAN-8 on page 118</a>	01 (enable)	01 (enable)	01 (enable)	01 (enable)	01 (enable)	01 (enable)
<a href="#">EAN-8 Check Character Transmission on page 119</a>	01 (enable)	01 (enable)	01 (enable)	01 (enable)	01 (enable)	01 (enable)
<a href="#">Expand EAN-8 to EAN-13 on page 120</a>	00 (disable)	00 (disable)	00 (disable)	00 (disable)	00 (disable)	00 (disable)
<a href="#">EAN-8 Minimum Read on page 121</a>	01 (1 read)	01 (1 read)	01 (1 read)	01 (1 read)	01 (1 read)	01 (1 read)
<a href="#">EAN-8 Guard Insertion on page 122</a>	00 (disable)	00 (disable)	00 (disable)	00 (disable)	00 (disable)	00 (disable)
<a href="#">EAN-8 Guard Substitution on page 123</a>	00 (disable)	00 (disable)	00 (disable)	00 (disable)	00 (disable)	00 (disable)
<a href="#">EAN-8/Jan-8 Both Guards Substitution on page 124</a>	00 (disable)	00 (disable)	00 (disable)	00 (disable)	00 (disable)	00 (disable)
<a href="#">EAN-8 Stitch Exact Label Halves on page 125</a>	00 (disable)	00 (disable)	00 (disable)	00 (disable)	00 (disable)	00 (disable)
<a href="#">EAN-8 Stitch Unlike Label Halves on page 126</a>	00 (disable)	00 (disable)	00 (disable)	00 (disable)	00 (disable)	00 (disable)
<a href="#">EAN-8 Minimum Segment Length on page 127</a>	08	08	08	08	08	08

Feature	Default Master	RS-232	RS-232 Wincor- Nixdorf	Keyboard	USB COM / USB TEC	USB OEM
EAN-8 Decoding Levels on page 129	01 (very conservative)	01 (very conservative)	01 (very conservative)	01 (very conservative)	01 (very conservative)	01 (very conservative)
In-Store Printed Label Minimum Read on page 130	01 (1 read)	01 (1 read)	01 (1 read)	01 (1 read)	01 (1 read)	01 (1 read)
UPC/EAN Correlation on page 131	00 (disable)	00 (disable)	00 (disable)	00 (disable)	00 (disable)	00 (disable)
UPC/EAN Guard Insertion on page 132	00 (disable)	00 (disable)	00 (disable)	00 (disable)	00 (disable)	00 (disable)
UPC/EAN Stitch Exact Label Halves on page 133	00 (disable)	00 (disable)	00 (disable)	00 (disable)	00 (disable)	00 (disable)
UPC/EAN Stitch Unlike Label Halves on page 134	00 (disable)	00 (disable)	00 (disable)	00 (disable)	00 (disable)	00 (disable)
UPC/EAN Minimum Segment Length on page 135	05 (5 char.)	05 (5 char.)	05 (5 char.)	05 (5 char.)	05 (5 char.)	05 (5 char.)
Price Weight Check on page 137	00 (disable)	00 (disable)	00 (disable)	00 (disable)	00 (disable)	00 (disable)
Enable EAN Two Label on page 139	00 (disable)	00 (disable)	00 (disable)	00 (disable)	00 (disable)	00 (disable)
EAN Two Label Minimum Read on page 140	01 (1 read)	01 (1 read)	01 (1 read)	01 (1 read)	01 (1 read)	01 (1 read)
EAN Two Label Combined Transmission on page 141	00 (disable)	00 (disable)	00 (disable)	00 (disable)		
Add-ons on page 142	disable all	disable all	disable all	disable all	disable all	disable all
P2 Add-on Minimum Read on page 143	02 (2 reads)	02 (2 reads)	02 (2 reads)	02 (2 reads)	02 (2 reads)	02 (2 reads)
P5 Add-on Minimum Read on page 146	01 (1 read)	01 (1 read)	01 (1 read)	01 (1 read)	01 (1 read)	01 (1 read)
UPC/EAN Composites on page 149	00 (disable)	00 (disable)	00 (disable)	00 (disable)	00 (disable)	
GTIN on page 150	00 (disable)	00 (disable)	00 (disable)	00 (disable)	00 (disable)	
DataBar Omnidirectional Enable on page 151	00 (disable)	00 (disable)	00 (disable)	00 (disable)	00 (disable)	00 (disable)

Feature	Default Master	RS-232	RS-232 Wincor- Nixdorf	Keyboard	USB COM / USB TEC	USB OEM
DataBar Omnidirectional/EAN-128 Emulation on page 152	00 (disable)	00 (disable)	00 (disable)	00 (disable)	00 (disable)	00 (disable)
DataBar Omnidirectional 2D Component Enable on page 153	00 (disable)	00 (disable)	00 (disable)	00 (disable)	00 (disable)	00 (disable)
DataBar Omnidirectional Minimum Read on page 154	01 (1 read)	01 (1 read)	01 (1 read)	01 (1 read)	01 (1 read)	01 (1 read)
DataBar Omnidirectional Double Read Timeout on page 155	2.5 Sec.	2.5 Sec.	2.5 Sec.	2.5 Sec.	2.5 Sec.	2.5 Sec.
DataBar Limited Enable on page 156	00 (disable)	00 (disable)	00 (disable)	00 (disable)	00 (disable)	00 (disable)
DataBar Limited Minimum Read on page 157	01 (1 read)	01 (1 read)	01 (1 read)	01 (1 read)	01 (1 read)	01 (1 read)
DataBar Limited 2D Component Enable on page 158	00 (disable)	00 (disable)	00 (disable)	00 (disable)	00 (disable)	00 (disable)
DataBar Limited EAN128 Emulation Enable on page 159	00 (disable)	00 (disable)	00 (disable)	00 (disable)	00 (disable)	00 (disable)
DataBar Expanded on page 160	00 (disable)	00 (disable)	00 (disable)	00 (disable)	00 (disable)	00 (disable)
DataBar Expanded EAN-128 Emulation on page 161	00 (disable)	00 (disable)	00 (disable)	00 (disable)	00 (disable)	00 (disable)
DataBar Expanded 2D Component Enable on page 162	00 (disable)	00 (disable)	00 (disable)	00 (disable)	00 (disable)	00 (disable)
DataBar Expanded Minimum Read on page 163	01 (1 read)	01 (1 read)	01 (1 read)	01 (1 read)	01 (1 read)	01 (1 read)
DataBar Expanded Length Control on page 164	00 (variable)	00 (variable)	00 (variable)	00 (variable)	00 (variable)	00 (variable)
DataBar Expanded Length 1 on page 165	01	01	01	01	01	01
DataBar Expanded Length 2 on page 166	4A	4A	4A	4A	4A	4A

Feature	Default Master	RS-232	RS-232 Wincor- Nixdorf	Keyboard	USB COM / USB TEC	USB OEM
DataBar Expanded Reverse Retry on page 167	00 (disable)	00 (disable)	00 (disable)	00 (disable)	00 (disable)	00 (disable)
Code 39 on page 168	01 (enable)	01 (enable)	01 (enable)	01 (enable)	01 (enable)	01 (enable)
Code 39 Start Stop Character Transmission on page 169	00 (disable)	00 (disable)	00 (disable)	00 (disable)	00 (disable)	00 (disable)
Code 39 Check Character Calculation on page 170	00 (disable)	00 (disable)	00 (disable)	00 (disable)	00 (disable)	00 (disable)
Code 39 Check Character Transmission on page 171	01 (enable)	01 (enable)	01 (enable)	01 (enable)	01 (enable)	01 (enable)
Code 39 Full ASCII on page 172	00 (disable)	00 (disable)	00 (disable)	00 (disable)	00 (disable)	00 (disable)
Code 39 Minimum Read on page 173	01 (1 read)	01 (1 read)	01 (1 read)	01 (1 read)	01 (1 read)	01 (1 read)
Code 39 Correlation on page 174	00 (disable)	00 (disable)	00 (disable)	00 (disable)	00 (disable)	00 (disable)
Code 39 Length Control on page 175	00 (variable)	00 (variable)	00 (variable)	00 (variable)	00 (variable)	00 (variable)
Code 39 Length 1 on page 176	02	02	02	02	02	02
Code 39 Length 2 on page 177	32	32	32	32	32	32
Code 39 Stitching on page 178	01 (enable)	01 (enable)	01 (enable)	01 (enable)	01 (enable)	01 (enable)
Code 39 Require Margins on page 179	00 (disable)	00 (disable)	00 (disable)	00 (disable)	00 (disable)	00 (disable)
Code 32 Italian Pharmacode on page 180	00 (disable)	00 (disable)	00 (disable)	00 (disable)	00 (disable)	00 (disable)
Code 32 Start Stop Character Transmission on page 181	00 (disable)	00 (disable)	00 (disable)	00 (disable)	00 (disable)	00 (disable)
Code 32 Check Character Transmission on page 182	00 (disable)	00 (disable)	00 (disable)	00 (disable)	00 (disable)	
Code 128 on page 183	01 (enable)	01 (enable)	01 (enable)	01 (enable)	01 (enable)	01 (enable)



Feature	Default Master	RS-232	RS-232 Wincor- Nixdorf	Keyboard	USB COM / USB TEC	USB OEM
<a href="#">Code 128 Transmit Function Characters on page 184</a>	00 (disable)	00 (disable)	00 (disable)	00 (disable)	00 (disable)	00 (disable)
<a href="#">Expand Code128 to Code 39 on page 185</a>	00 (disable)	00 (disable)	00 (disable)	00 (disable)	00 (disable)	00 (disable)
<a href="#">Code 128 Minimum Read on page 186</a>	01 (1 read)	01 (1 read)	01 (1 read)	01 (1 read)	01 (1 read)	01 (1 read)
<a href="#">Code 128 Correlation on page 187</a>	00 (disable)	00 (disable)	00 (disable)	00 (disable)	00 (disable)	00 (disable)
<a href="#">Code 128 Length Control on page 188</a>	00 (variable)	00 (variable)	00 (variable)	00 (variable)	00 (variable)	00 (variable)
<a href="#">Code 128 Length 1 on page 189</a>	01	01	01	01	01	01
<a href="#">Code 128 Length 2 on page 190</a>	50	50	50	50	50	50
<a href="#">Code 128 Stitching on page 191</a>	01 (enable)	01 (enable)	01 (enable)	01 (enable)	01 (enable)	01 (enable)
<a href="#">EAN-128 on page 192</a>	00 (disable)	00 (disable)	00 (disable)	00 (disable)	00 (disable)	00 (disable)
<a href="#">Interleaved 2 of 5 (I 2 OF 5) on page 193</a>	00 (disable)	00 (disable)	00 (disable)	00 (disable)	00 (disable)	00 (disable)
<a href="#">I 2 of 5 Check Character Calculation on page 194</a>	00 (disable)	00 (disable)	00 (disable)	00 (disable)	00 (disable)	00 (disable)
<a href="#">I 2 of 5 Check Character Transmission on page 195</a>	01 (enable)	01 (enable)	01 (enable)	01 (enable)	01 (enable)	01 (enable)
<a href="#">I 2 of 5 Minimum Read on page 196</a>	01 (1 read)	01 (1 read)	01 (1 read)	01 (1 read)	01 (1 read)	01 (1 read)
<a href="#">I 2 of 5 Correlation on page 197</a>	00 (disable)	00 (disable)	00 (disable)	00 (disable)	00 (disable)	00 (disable)
<a href="#">I 2 of 5 Length Control on page 198</a>	00 (variable)	00 (variable)	00 (variable)	00 (variable)	00 (variable)	00 (variable)
<a href="#">I 2 of 5 Length 1 on page 199</a>	06	06	06	06	06	06
<a href="#">I 2 of 5 Length 2 on page 200</a>	32	32	32	32	32	32
<a href="#">I 2 of 5 Stitching on page 201</a>	00 (disable)	00 (disable)	00 (disable)	00 (disable)	00 (disable)	00 (disable)

Feature	Default Master	RS-232	RS-232 Wincor- Nixdorf	Keyboard	USB COM / USB TEC	USB OEM
Codabar on page 202	00 (disable)	00 (disable)	00 (disable)	00 (disable)	00 (disable)	00 (disable)
Codabar Start Stop Character Transmission on page 203	01 (enable)	01 (enable)	01 (enable)	01 (enable)	01 (enable)	01 (enable)
Codabar Start Stop Character Set on page 204	03 (abcd/abcd)	03 (abcd/abcd)	03 (abcd/abcd)	03 (abcd/abcd)	03 (abcd/abcd)	03 (abcd/abcd)
Codabar Start Stop Character Match on page 205	00 (disable)	00 (disable)	00 (disable)	00 (disable)	00 (disable)	00 (disable)
Codabar Check Character Calculation on page 206	00 (disable)	00 (disable)	00 (disable)	00 (disable)	00 (disable)	00 (disable)
Codabar Check Character Transmission on page 207	01 (enable)	01 (enable)	01 (enable)	01 (enable)	01 (enable)	01 (enable)
Codabar Minimum Read on page 208	01 (1 read)	01 (1 read)	01 (1 read)	01 (1 read)	01 (1 read)	01 (1 read)
Codabar Correlation on page 209	00 (disable)	00 (disable)	00 (disable)	00 (disable)	00 (disable)	00 (disable)
Codabar Length Control on page 210	00 (variable)	00 (variable)	00 (variable)	00 (variable)	00 (variable)	00 (variable)
Codabar Length 1 on page 211	03	03	03	03	03	03
Codabar Length 2 on page 212	32	32	32	32	32	32
Codabar Stitching on page 213	00 (disable)	00 (disable)	00 (disable)	00 (disable)	00 (disable)	00 (disable)
Codabar Require Margins on page 214	00 (disable)	00 (disable)	00 (disable)	00 (disable)	00 (disable)	00 (disable)
Code 93 on page 215	00 (disable)	00 (disable)	00 (disable)	00 (disable)	00 (disable)	00 (disable)
Code 93 Minimum Read on page 216	01 (1 read)	01 (1 read)	01 (1 read)	01 (1 read)	01 (1 read)	01 (1 read)
Code 93 Correlation on page 217	00 (disable)	00 (disable)	00 (disable)	00 (disable)	00 (disable)	00 (disable)
Code 93 Length Control on page 218	00 (variable)	00 (variable)	00 (variable)	00 (variable)	00 (variable)	00 (variable)

Feature	Default Master	RS-232	RS-232 Wincor- Nixdorf	Keyboard	USB COM / USB TEC	USB OEM
Code 93 Length 1 on page 219	01	01	01	01	01	01
Code 93 Length 2 on page 220	32	32	32	32	32	32
Code 93 Stitching on page 221	01 (enable)	01 (enable)	01 (enable)	01 (enable)	01 (enable)	01 (enable)
MSI on page 222	00 (disable)	00 (disable)	00 (disable)	00 (disable)	00 (disable)	
MSI Check Character Calculation on page 223	01 (enable)	01 (enable)	01 (enable)	01 (enable)	01 (enable)	
MSI Number of Check Characters on page 224	00 (1 char)	00 (1 char)	00 (1 char)	00 (1 char)	00 (1 char)	
MSI Check Character Transmission on page 225	01 (enable)	01 (enable)	01 (enable)	01 (enable)	01 (enable)	
MSI Minimum Read on page 226	01 (1 read)	01 (1 read)	01 (1 read)	01 (1 read)	01 (1 read)	
MSI Correlation on page 227	00 (disable)	00 (disable)	00 (disable)	00 (disable)	00 (disable)	
MSI Length Control on page 228	00 (variable)	00 (variable)	00 (variable)	00 (variable)	00 (variable)	
MSI Length 1 on page 229	04	04	04	04	04	
MSI Length 2 on page 230	10	10	10	10	10	
MSI Stitching on page 231	00 (disable)	00 (disable)	00 (disable)	00 (disable)	00 (disable)	
Standard 2 of 5 on page 232	00 (disable)	00 (disable)	00 (disable)	00 (disable)	00 (disable)	00 (disable)
Standard 2 of 5 Check Character Calculation on page 233	00 (disable)	00 (disable)	00 (disable)	00 (disable)	00 (disable)	00 (disable)
Standard 2 of 5 Check Character Transmission on page 234	01 (enable)	01 (enable)	01 (enable)	01 (enable)	01 (enable)	01 (enable)
Standard 2 of 5 Minimum Read on page 235	01 (1 read)	01 (1 read)	01 (1 read)	01 (1 read)	01 (1 read)	01 (1 read)
Standard 2 of 5 Correlation on page 236	00 (disable)	00 (disable)	00 (disable)	00 (disable)	00 (disable)	00 (disable)

Feature	Default Master	RS-232	RS-232 Wincor- Nixdorf	Keyboard	USB COM / USB TEC	USB OEM
Standard 2 of 5 Length Control on page 237	00 (variable)	00 (variable)	00 (variable)	00 (variable)	00 (variable)	00 (variable)
Standard 2 of 5 Length 1 on page 238	08	08	08	08	08	08
Standard 2 of 5 Length 2 on page 239	32	32	32	32	32	32
Standard 2 of 5 Stitching on page 240	00 (disable)	00 (disable)	00 (disable)	00 (disable)	00 (disable)	00 (disable)
<b>2D Symbology Programming</b>						
Data Matrix on page 242	00 (disable)	00 (disable)	00 (disable)	00 (disable)	00 (disable)	00 (disable)
Data Matrix Length Control on page 243	00 (variable)	00 (variable)	00 (variable)	00 (variable)	00 (variable)	00 (variable)
Set Data Matrix Length 1 on page 244	0001	0001	0001	0001	0001	0001
Set Data Matrix Length 2 on page 244	0320	0320	0320	0320	0320	0320
GS1 Datamatrix Enable on page 245	00 (transmit as std Data-matrix label)	00 (transmit as std Data-matrix label)	01 (transmit as GS1 Data-matrix label)	00 (transmit as std Data-matrix label)	00 (transmit as std Data-matrix label)	00 (transmit as std Data-matrix label)
PDF 417 Enable on page 246	00 (disable)	00 (disable)	00 (disable)	00 (disable)	00 (disable)	00 (disable)
PDF 417 Length Control on page 247	00 (variable)	00 (variable)	00 (variable)	00 (variable)	00 (variable)	00 (variable)
Set PDF 417 Length 1 on page 248	0001	0001	0001	0001	0001	0001
Set PDF 417 Length 2 on page 248	0A96	0A96	0A96	0A96	0A96	0A96
PDF 417 Read Option on page 249	00 (none)	00 (none)	00 (none)	00 (none)	00 (none)	00 (none)
Micro PDF 417 on page 250	00 (disable)	00 (disable)	00 (disable)	00 (disable)	00 (disable)	00 (disable)
Micro PDF 417 Length Control on page 251	00 (variable)	00 (variable)	00 (variable)	00 (variable)	00 (variable)	00 (variable)
Set Micro PDF 417 Length 1 on page 252	0001	0001	0001	0001	0001	0001
Set Micro PDF 417 Length 2 on page 252	016E	016E	016E	016E	016E	016E

Feature	Default Master	RS-232	RS-232 Wincor- Nixdorf	Keyboard	USB COM / USB TEC	USB OEM
<a href="#">Micro PDF 417 128 Emulation on page 253</a>	00 (Micro PDF 417 AIM ID & label type)	00 (Micro PDF 417 AIM ID & label type)	00 (Micro PDF 417 AIM ID & label type)	00 (Micro PDF 417 AIM ID & label type)	00 (Micro PDF 417 AIM ID & label type)	00 (Micro PDF 417 AIM ID & label type)
<a href="#">QR Code on page 254</a>	00 (disable)	00 (disable)	00 (disable)	00 (disable)	00 (disable)	00 (disable)
<a href="#">QR Code Length Control on page 255</a>	00 (variable)	00 (variable)	00 (variable)	00 (variable)	00 (variable)	00 (variable)
<a href="#">Set QR Code Length 1 on page 256</a>	0001	0001	0001	0001	0001	0001
<a href="#">Set QR Code Length 2 on page 256</a>	0A96	0A96	0A96	0A96	0A96	0A96
<a href="#">QR Code URL Link Enable on page 257</a>	00 (disable)	00 (disable)	00 (disable)	00 (disable)	00 (disable)	00 (disable)
<a href="#">GS1 QR Code Enable on page 258</a>	00 (transmit as std QR Code label)	00 (transmit as std QR Code label)	01 (transmit as GS1 QR Code label)	00 (transmit as std QR Code label)	00 (transmit as std QR Code label)	00 (transmit as std QR Code label)
<a href="#">Micro QR Code on page 259</a>	00 (disable)	00 (disable)	00 (disable)	00 (disable)	00 (disable)	00 (disable)
<a href="#">Micro QR Code Length Control on page 260</a>	00 (variable)	00 (variable)	00 (variable)	00 (variable)	00 (variable)	00 (variable)
<a href="#">Set Micro QR Code Length 1 on page 261</a>	0001	0001	0001	0001	0001	0001
<a href="#">Set Micro QR Code Length 2 on page 261</a>	0E74	0E74	0E74	0E74	0E74	0E74
<a href="#">Aztec Code on page 262</a>	00 (disable)	00 (disable)	00 (disable)	00 (disable)	00 (disable)	00 (disable)
<a href="#">Aztec Length Control on page 263</a>	00 (variable)	00 (variable)	00 (variable)	00 (variable)	00 (variable)	00 (variable)
<a href="#">Set Aztec Length 1 on page 264</a>	0001	0001	0001	0001	0001	0001
<a href="#">Set Aztec Length 2 on page 264</a>	0E74	0E74	0E74	0E74	0E74	0E74



# Appendix E

## Keyboard Function Key Mappings

### USB Function Key Usage Map

ASCII	Key value	Usage Name	Modifier/Scancode
02	STX	F11	00h 44h
03	ETX	F12	00h 45h
04	EOT	GUI right Make	80h 00h
05	ENQ	GUI right Break	00h 00h
06	ACK	CTRL right Make	10h 00h
07	BEL	CTRL right Break	00h 00h
08	BS	BS	00h 2Ah
09	HT	TAB right	00h 2Bh
0A	LF	RIGHT arrow (inner keypad)	00h 4Fh
0B	VT	TAB left	02h 2Bh
0C	FF	Enter (right keypad)	00h 58h
0D	CR	CR	00h 28h
0E	SO	INSERT (inner keypad)	00h 49h
0F	SI	PAGE UP (inner keypad)	00h 4Bh
10	DLE	PAGE DOWN (inner keypad)	00h 4Eh
11	DC1	HOME (inner keypad)	00h 4Ah
12	DC2	LEFT arrow (inner keypad)	00h 50h
13	DC3	DOWN arrow (inner keypad)	00h 51h
14	DC4	UP arrow (inner keypad)	00h 52h
15	NAK	F6	00h 3Fh
16	SYN	F1	00h 3Ah
17	ETB	F2	00h 3Bh
18	CAN	F3	00h 3Ch
19	EM	F4	00h 3Dh
1A	SUB	F5	00h 3Eh
1B	ESC	ESC	00h 29h
1C	FS	F7	00h 40h
1D	GS	F8	00h 41h
1E	RS	F9	00h 42h
1F	US	F10	00h 43h

The following keys can be optionally configured to correspond to the Rev C version of this function table. See “USB Keyboard Additional Interface Options” on page 82 to set this feature.

ASCII	Key value	Usage Name	Modifier/Scancode
02	STX	F11	00h 44h
03	ETX	F12	00h 45h
04	EOT	GUI right Make	80h 00h
05	ENQ	GUI right Break	00h 00h

**Table 1. Scanset 1 Function Key Map**

ASCII (hex)	ASCII code	Key	Scancode
02	STX	ALT left Make	38h
03	ETX	ALT left Break	B8h
04	EOT	CTRL left Make	1Dh
05	ENQ	CTRL left Break	9Dh
06	ACK	CTRL right Make	E0h 1Dh
07	BEL	CTRL right Break	E0h 9Dh
08	BS	BS	0Eh
09	HT	TAB right	0Fh
0A	LF	RIGHT arrow (inner keypad)	4Dh + E0
0B	VT	TAB left	0Fh + S
0C	FF	Enter (inner keypad)	1Ch + E0
0D	CR	CR	1Ch
0E	SO	INSERT (inner keypad)	52h + E0
0F	SI	PAGE UP (inner keypad)	49h + E0
10	DLE	PAGE DOWN (inner keypad)	51h + E0
11	DC1	HOME (inner keypad)	47h + E0
12	DC2	LEFT arrow (inner keypad)	4Bh + E0
13	DC3	DOWN arrow (inner keypad)	50h + E0
14	DC4	UP arrow (inner keypad)	48h + E0

**Table 2. Scanset 2 Function Key Map**

ASCII (hex)	ASCII code	Key	Scancode
02	STX	ALT left Make	11h
03	ETX	ALT left Break	F0h 11h
04	EOT	CTRL left Make	14h
05	ENQ	CTRL left Break	F0h 14h
06	ACK	CTRL right Make	E0h 14h
07	BEL	CTRL right Break	E0h F0h 14h
08	BS	BS	66h
09	HT	TAB right	0Dh
0A	LF	RIGHT arrow (inner keypad)	74h + E0
0B	VT	TAB left	0Dh + S
0C	FF	Enter (right keypad)	5Ah + E0
0D	CR	CR	5Ah
0E	SO	INSERT (inner keypad)	70h + E0
0F	SI	PAGE UP (inner keypad)	7Dh + E0
10	DLE	PAGE DOWN (inner keypad)	7Ah + E0
11	DC1	HOME (inner keypad)	6Ch + E0
12	DC2	LEFT arrow (inner keypad)	6Bh + E0
13	DC3	DOWN arrow (inner keypad)	72h + E0
14	DC4	UP arrow (inner keypad)	75h + E0
15	NAK	F6	0Bh
16	SYN	F1	05h
17	ETB	F2	06h
18	CAN	F3	04h
19	EM	F4	0Ch
1A	SUB	F5	03h
1B	ESC	ESC	76h

1C	FS	F7	83h
1D	GS	F8	0Ah
1E	RS	F9	01h
1F	US	F10	09h

**Table 3. Scanset 3, 102-Key Function Key Map**

ASCII (hex)	ASCII code	Key	Scancode
02	STX	ALT left Make	19h
03	ETX	ALT left Break	F0h 19h
04	EOT	CTRL left Make	11h
05	ENQ	CTRL left Break	F0h 11h
06	ACK	CTRL right Make	58h
07	BEL	CTRL right Break	F0h 58h
08	BS	BS	66h
09	HT	TAB right	0Dh
0A	LF	RIGHT arrow (inner keypad)	6Ah
0B	VT	TAB left	0Dh + S
0C	FF	Enter (inner keypad)	79h
0D	CR	CR	5Ah
0E	SO	INSERT (inner keypad)	67h
0F	SI	PAGE UP (inner keypad)	6Fh
10	DLE	PAGE DOWN (inner keypad)	6Dh
11	DC1	HOME (inner keypad)	6Eh
12	DC2	LEFT arrow (inner keypad)	61h
13	DC3	DOWN arrow (inner keypad)	60h
14	DC4	UP arrow (inner keypad)	63h
15	NAK	F6	2Fh
16	SYN	F1	07h
17	ETB	F2	0Fh
18	CAN	F3	17h
19	EM	F4	1Fh
1A	SUB	F5	27h
1B	ESC	ESC	08h
1C	FS	F7	37h
1D	GS	F8	3Fh
1E	RS	F9	47h
1F	US	F10	4Fh



**Table 4. Scanset 3 122-Key Function Key Map**

<b>ASCII (hex)</b>	<b>ASCII code</b>	<b>Key</b>	<b>Scancode</b>
02	STX	ALT left Make	19h
03	ETX	ALT left Break	F0h 19h
04	EOT	CTRL left (RESET) Make only	11h
05	ENQ	CTRL left (RESET) Make/Break	11h F0h 11h
06	ACK	ONLINE Enter Make only	58h
07	BEL	ONLINE Enter Make/Break	58h F0h 58h
08	BS	BS	66h
09	HT	TAB right	0Dh
0A	LF	RIGHT arrow (inner keypad)	6Ah
0B	VT	TAB left	0Dh + S
0C	FF	CR (FIELD EXIT) Make only	5Ah F0h 5Ah
0D	CR	CR (FIELD EXIT) Make/Break	5Ah
0E	SO	INSERT (inner keypad)	65h
0F	SI	FIELD +	79h
10	DLE	FIELD -	7Ch
11	DC1	HOME (inner keypad)	62h
12	DC2	LEFT arrow (inner keypad)	61h
13	DC3	DOWN arrow (inner keypad)	60h
14	DC4	UP arrow (inner keypad)	63h
15	NAK	F6	2Fh
16	SYN	F1	07h
17	ETB	F2	0Fh
18	CAN	F3	17h
19	EM	F4	1Fh
1A	SUB	F5	27h
1B	ESC	ESC	08h
1C	FS	F7	37h
1D	GS	F8	3Fh
1E	RS	F9	47h
1F	US	F10	4Fh

---

**Table 5. Japanese DOS Function Key Map**

ASCII value	ASCII code	Key	Scancode
02h	STX	ALT left Make	31h
03h	ETX	ALT left Break	B1h
04h	EOT	CTRL left Make	41h
05h	ENQ	CTRL left Break	C1h
06h	ACK	CTRL right Make	41h
07h	BEL	CTRL right Break	C1h
08h	BS	BS	3Eh
09h	HT	TAB right	3Ch
0Ah	LF	RIGHT arrow (inner keypad)	4Dh
0Bh	VT	TAB left	3Ch + S
0Ch	FF	Enter (right keypad)	60h
0Dh	CR	CR	3Bh
0Eh	SO	INSERT (inner keypad)	52h
0Fh	SI	PAGE UP (inner keypad)	49h
10h	DLE	PAGE DOWN (inner keypad)	51h
11h	DC1	HOME (inner keypad)	4Ch
12h	DC2	LEFT arrow (inner keypad)	4Bh
13h	DC3	DOWN arrow (inner keypad)	4Ah
14h	DC4	UP arrow (inner keypad)	4Eh
15h	NAK	F6	6Dh
16h	SYN	F1	68h
17h	ETB	F2	69h
18h	CAN	F3	6Ah
19h	EM	F4	6Bh
1Ah	SUB	F5	6Ch
1Bh	ESC	ESC	3Dh
1Ch	FS	F7	6Eh
1Dh	GS	F8	6Fh
1Eh	RS	F9	70h
1Fh	US	F10	71h

**Table 6. NEC 9801-Key Function Key Map**

ASCII value	ASCII code	Key	Scancode
00h	NUL	unused	n/a
01h	SOH	CR	1Ch
02h	STX	CAPS LOCK ON (make)	71h
03h	ETX	CAPS LOCK OFF (break)	F1h
04h	EOT	CTRL left Make	74h
05h	ENQ	CTRL left Break	F4h
06h	ACK	CTRL-C	60h
07h	BEL	n/a	n/a
08h	BS	BS	0Eh
09h	HT	TAB right	0Fh
0Ah	LF	RIGHT arrow (inner keypad)	3Ch
0Bh	VT	TAB left	0Fh + S
0Ch	FF	DELETE	39h
0Dh	CR	CR	1Ch
0Eh	SO	INSERT (inner keypad)	38h
0Fh	SI	KATAKANA LOCK ON (Make)	72h
10h	DLE	KATAKANA LOCK OFF (Break)	F2h
11h	DC1	HOME (inner keypad)	3Eh
12h	DC2	LEFT arrow (inner keypad)	3Bh
13h	DC3	DOWN arrow (inner keypad)	3Dh
14h	DC4	UP arrow (inner keypad)	3Ah
15h	NAK	F6	67h
16h	SYN	F1	62h
17h	ETB	F2	63h
18h	CAN	F3	64h
19h	EM	F4	65h
1Ah	SUB	F5	66h
1Bh	ESC	ESC	00h
1Ch	FS	F7	68h
1Dh	GS	F8	69h
1Eh	RS	F9	6Ah
1Fh	US	F10	6Bh



# Appendix F

## Host Commands

### Accepting RS-232 Commands

The scanner responds to the following RS-232 commands:

COMMAND	ASCII	HEX	COMMENT
Enable Scanner	E	0x45	
Disable Scanner	D	0x44	
Reset Scanner	R	0x52	
Not On File Indication	F	0x46	Long series of beeps
Beep Good Read Tone	B	0x42	Beeps if Good Read Beep is enabled
Force Good Read Tone	!	0x01	Beeps regardless of beep setting
Identification request	i	0x69	Returns long response <sup>a</sup>
Health request	h	0x68	Returns long response <sup>a</sup>
Status request	s	0x73	Returns long response <sup>a</sup>
Beep on ASCII BEL	!	0x07	Beeps if Beep on ASCII BEL is enabled

a. Call Tech Support for information.

If one of the above commands is received, the scanner will perform the steps indicated for the command. Host commands for other interfaces are also available. Contact Tech Support for more details.

Also see the section "[Image Capture to the Host by Host Command](#)" on page 90 for details concerning that feature.



# Appendix G

## Sample Symbols

### 1D Symbol Samples

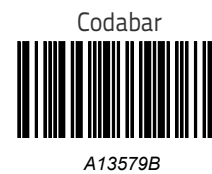
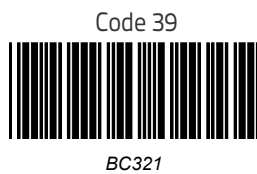
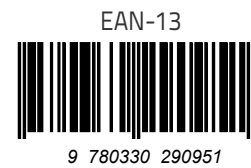
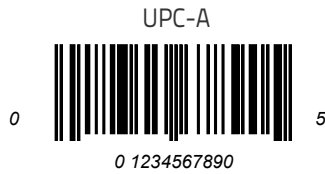

Code 2 of 5



GS1 DataBar Omnidirectional



GS1 DataBar Expanded



GS1 DataBar Limited



---

## 2D Sample Symbols

PDF 417



A12B3C

Micro PDF 417



BV17453

Datamatrix

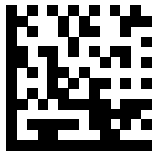

1314H17LL

QR Code

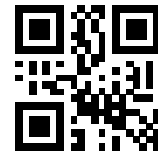

35900G9

Micro QR Code



ABCDEF

Aztec



This is an Aztec Code

## Composite Sample Symbols

GS1 DataBar Limited Composite

(17) 050923 (10) ABC123



(01) 0 4012345 67890 1

GS1 DataBar Truncated Composite

(17)050923(10)ABC123



(01) 09876543217899





# Appendix H microSD Card

## microSDHC Compatibility

At the time of this writing, the microSD card interface for this product supports SD–Memory Card Specifications/ Part 1. Physical Layer Specification; Version 1.01, but the processor MCI can communicate with SDHC Cards. For example, the scanner can perform the functions specified in this appendix for the SDA 2.0 specification. Both FAT16 and FAT32 formats are supported.

Filenames are limited to the 8.3 file naming format (i.e., **FILENAME.EXT**), and **MUST** be capitalized.

## microSD Card Insertion

1. Read all of these instructions before starting.
2. If you have not already done so, remove the scanner from its installed position to allow access to the microSD card slot.
3. Separate the scanner from its back cover.
4. Ensure there are no other cables attached to the scanner, then apply power and wait for the reset beep.
5. Lift and rotate the rubber cover to access the card slot, then carefully insert the microSD card into the slot until it "clicks" into place.

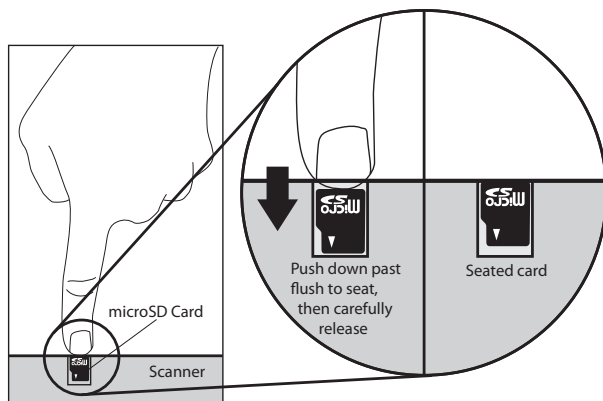



CAUTION

The microSD card slot is spring loaded. Keep your finger lightly in place atop the card until you are sure it is fully seated in place. See the illustration on the following page.

Use your finger or thumbnail to push in on the top edge of the card to be slightly below flush with the scanner enclosure when inserting or removing the card. This will engage/disengage the spring mechanism.

Never insert tools or other foreign objects into the microSD card slot.

6. If installed properly, you should immediately hear an audible signal upon insertion or removal of a microSD card. Various operations will also be indicated by the scanner's good read LED.

## microSD Card Removal

1. Push in gently using your finger or thumbnail to disengage and remove the microSD card. Remember to keep your finger in place atop the card's edge to avoid accidentally "launching" the card from the spring-loaded slot.
2. Reconnect all cables which were disconnected earlier.

## Autorun File Processing

After insertion of the card, the scanner will mount the microSD card and search for the file "**AUTORUN.DLS**". Embedded in that file is a validation pattern of the ASCII strings "\$START\$" and "\$END\$" located at the respective starting and ending of the file.

If the validation pattern is found, the file may contain any of the following commands. The scanner will parse the file taking action according to these commands. Filenames in **this format** specify a user-defined name.

Example AUTORUN.DLS file:

```
$START$ (required)
CONFIG, FILENAME.TEX
DUMPSTATS, FILENAME.TXT
DUMPCFG, FILENAME.TEX
LOADSW, FILENAME.S37
$END$ (required)
```

## microSD Function Summary

The following table summarizes various functions of microSD card. Contact tech support regarding upgrade license for new features.

FUNCTION		Export Status	Export Configuration	Load Applic	Load Config	Load CPLD Code <sup>a</sup>	Feature Upgrade <sup>b</sup>
Direction	Scanner ⇒ microSD Card	√	√				
	microSD Card ⇒ Scanner			√	√	√	√
Initiated by	Scanning a label			√	√		
	AUTORUN.DLS file in microSD card	√	√	√	√	√	√

a. The only way to load CPLD code (i.e., FPGA code) is to load a new application package.

b. The only way to do a feature upgrade is to load a new application package.

## microSD Function Details

### From Scanner to microSD Card

#### Export a Configuration file from the Scanner to the microSD card

##### By AUTORUN.DLS file

1. Generate a text file by any text editor as follows and save it as **AUTORUN.DLS**.
 

```

$START$
DUMPCFG,SDCONFIG.TEX (Filename can be anything, for example
"SOMETHING.TEX")
$END$

```
2. Save or copy file AUTORUN.DLS to microSD card
3. Insert the microSD card to scanner
4. Wait for 3 seconds,
 

A scanner configuration file named **SDCONFIG.TXT** is saved to the microSD card.

## From microSD Card to Scanner

### Application code load to scanner

#### By AUTORUN.DLS file

1. Generate a text file by any text editor as follows and save it as **AUTORUN.DLS**

```
$START$  
LOADSW,R96-APP1.S37  
$END$
```
2. Step 2: Save or copy file **AUTORUN.DLS** to microSD card and copy the application code (example **R96-APP1.S37**) to the microSD card.
3. Insert the microSD card into the scanner.
4. Upon scanner audio indication of completion, the application code **R96-APP1.S37** is loaded to the scanner. Typically, this takes about 45 seconds.

### Configuration load to scanner

#### By Autorun file

1. Generate a text file by any text editor as follows and save it as **AUTORUN.DLS**

```
$START$  
CONFIG,R96-CFG1.TEX  
$END$
```
2. Save or copy the autorun.dls file, and copy the CPLD code (example **R96-CFG1.TEX**) to the microSD card
3. Insert the microSD card into to the scanner
4. Upon scanner audio indication of completion, configuration **R96-CFG1.TEX** is loaded to the scanner.



# Appendix I

## Handheld Data Format Requirements

This appendix provides application notes to describe the general format of data that can be accepted by the scanner from a handheld scanner connected via the USB port.

### Handheld Data Format Requirements General

- USB handhelds enumerate as a CDC ACM serial device.
- USB devices should also bracket the data with the RTS equivalent.
- The time between character transmission can be no longer than 50 milliseconds.
- Symbologies requiring fixed lengths (UPC/EAN) will enforce length requirements for validation of the label.
- Handheld will be required to transmit start and stop characters for Codabar and Code39 labels.
- Appropriate industrial length requirements will be enforced (if configured) for validation of the label.
- Maximum label lengths will be enforced for label validation (i.e. labels longer than the maximum label size will not be validated).
- Standard Datalogic formats generally use a single prefix character. see specific formats section.
- Maximum label size allowed including identifiers is 2714 bytes
- Recommendations:
  - Handheld should not be configured for audible label read indication.
  - Handheld should not be configured for visual label read indication.
  - Handheld should not be configured for continuous label read mode.

### Datalogic Handheld Data Format Requirements

The following sections describe label transmission formats that are typically observed in factory configurations of Datalogic handheld scanners.

#### GS1 DataBar Omnidirectional

- Prefix must be ASCII characters 'R4'
- Check character must be included in label
- Application identifier "01" must follow the prefix and precede the base label
- Label length excluding prefix characters must be 16 characters.
- Example: 'R40101044123456789'

#### GS1 DataBar Expanded

- Prefix must be ASCII characters 'R4'
- Check character must be included in label

### **UPC-A**

- Number system must be included in label data.
- Check digit must be included in label data and is assumed to be correct.
- Prefix must be an ASCII character 'A' – total length including prefix must be 13.
- Example: 'A060992011187'.

### **UPC-A with 2-Digit Supplemental**

- Number system must be included in label data.
- Check digit must be included in label data and is assumed to be correct.
- Supplemental data is appended to base label.
- Prefix must be an ASCII character 'A' – total length including prefix must be 15.
- Example: 'A06099201118712'.

### **UPC-A with 5-Digit Supplemental**

- Number system must be included in label data
- Check digit must be included in label data and is assumed to be correct
- Prefix must be an ASCII character 'A' – total length including prefix must be 18
- Example: 'A06099201118712345'

### **UPC-E**

- Number system must be included in label data
- Check digit must be included in label data and is assumed to be correct
- Prefix must be an ASCII character 'E' – total length including prefix must be 9
- Example: 'E09988750'

### **UPC-E with 2-Digit Supplemental**

- Number system must be included in label data.
- Check digit must be included in label data and is assumed to be correct.
- Supplemental data is appended to base label.
- Prefix must be an ASCII character 'E' – total length including prefix must be 11.
- Example: 'E0998875012'.

### **UPC-E with 5-Digit Supplemental**

- Number system must be included in label data.
- Check digit must be included in label data and is assumed to be correct.
- Prefix must be an ASCII character 'E' – total length including prefix must be 14.
- Example: 'E0998875012345'.

### **EAN-8**

- Check digit must be included in label data and is assumed to be correct

- Prefix must be an ASCII characters 'FF' – total length including prefix must be 10
- Example: 'FF00210126'

### **EAN-8 with 2-Digit Supplemental**

- Check digit must be included in label data and is assumed to be correct.
- Supplemental data is appended to base label.
- Prefix must be an ASCII characters 'FF' – total length including prefix must be 12.
- Example: 'FF0021012612'.

### **EAN-8 with 5-Digit Supplemental**

- Check digit must be included in label data and is assumed to be correct.
- Prefix must be an ASCII characters 'FF' – total length including prefix must be 15.
- Example: 'FF0021012612345'.

### **EAN-13**

- Check digit must be included in label data and is assumed to be correct
- Prefix must be an ASCII character 'F'– total length including prefix must be 14
- Example: 'F1101234567891'

### **EAN-13 with 2-Digit Supplemental**

- Check digit must be included in label data and is assumed to be correct
- Supplemental data is appended to base label
- Prefix must be an ASCII character 'F'– total length including prefix must be 16
- Example: 'F110123456789112'

### **EAN-13 with 5-Digit Supplemental**

- Check digit must be included in label data and is assumed to be correct.
- Prefix must be an ASCII character 'F'– total length including prefix must be 19.
- Example: 'F110123456789112345'.

### **Code 39**

- Check character must be included in label data.
- Label length including start, stop and check characters and excluding prefix character must meet requirements imposed by the main scanner's fixed or variable label length control for this symbology type.
- Start and stop characters "\*" must be included in label.
- Prefix must be an ASCII character '\*'.  
Example : '\*\*Code 39.TEST\*'.

### **Code 39-Pharmacode**

- Check character must be included in label data.

- Label length including start, stop and check characters and excluding prefix character must meet requirements imposed by the main scanner's fixed or variable label length control for this symbology type.
- Start and stop characters "\*" must be included in label.
- Prefix must be an ASCII character 'p'.
- Example: 'p\*123456789\*'.

### I 2 of 5

- Check character must be included in label data.
- Label length including check characters and excluding prefix character must meet requirements imposed by the main scanner's fixed or variable label length control for this symbology type.
- Prefix must be an ASCII character 'i'.
- Example: 'i0123456789'.

### Codabar

- Check character must be included in label data.
- Label length including check character and excluding prefix character must meet requirements imposed by the main scanner's fixed or variable label length control for this symbology type.
- Prefix must be an ASCII character '%'.
- Start stop character sets must meet the matching requirement set forth by the scanner configuration item *Start/Stop Character Match*.
- Start stop character sets must be of the form ABCD/ABCD and must be included in the label.
- Example: '%s\$99.95s' (the lower case 's' at each end of the example is a placeholder for the start stop character set).

### Code 128

- Prefix must be an ASCII character '#'.
- Label length excluding prefix character or function code 3 for Code 128 programming labels must meet requirements imposed by the main scanner's fixed or variable label length control for this symbology type.
- Function characters may be transmitted as a hexadecimal value 8x. Where x correlates to function characters 1 thru 4 as follows:
  - x80 = function code 1
  - x81 = function code 2
  - x82 = function code 3
  - x83 = function code 4
- For Code 128 programming labels the format is of the general form '#/82nnnnn/r' - /82 is hexadecimal 82 and /r is carriage return.
- Example: '#Code\_128.Test'.

### MSI

- Check character must be included in label data.
- Label length including check character and excluding prefix character must meet requirements imposed by the main scanner's fixed or variable label length control for this symbology type.
- Prefix must be an ASCII character '@'.



- Example: '@144769254'.

### Code 93

- Prefix must be an ASCII character '&'.
- Label length excluding prefix character must meet requirements imposed by the main scanner's fixed or variable label length control for this symbology type.
- Example: '&Code93-test'.

### PDF417

- Prefix must be an ASCII character 'P'.
- Label length excluding prefix character cannot exceed 300 characters. In addition to this, label length excluding prefix character must meet requirements imposed by the main scanner's fixed or variable label length control for this symbology type.

## AIM Formats

AIM specifies a 3-character string that is attached as a prefix to the label data for transmission. Because AIM specifies one identifier for UPC-A, UPC-E and EAN-13 labels, UPC-A, UPC-E and EAN-13 will be received from the handheld and transmitted by the scanner as EAN-13. The ']' character must be the first character received in the label transmission from the handheld.

The following sections describe the prefix strings and identify what specific label characteristics can be supported.

### UPC-A

- AIM does not specify UPC-A as a separate symbology using this transmission format – labels will be transmitted as EAN-13.
- Example: ']E00060992011187'.

### UPC-E

- AIM does not specify UPC-E as a separate symbology using this transmission format – labels will be transmitted as EAN-13.
- Example: ']E00000000998875'.

### EAN-13

- Check digit must be included in label data and is assumed to be correct.
- Prefix must be ASCII characters ']E0' – total length including prefix must be 16.
- Example: ']E01101234567891'.

### EAN-8

- Check digit must be included in label data and is assumed to be correct.
- Prefix must be ASCII characters ']E4' – total length including prefix must be 11.
- Example: ']E400210126'.

## 2-Digit Supplemental

- Supplemental data is appended to any EAN base label.
- Prefix must be ASCII characters 'J'E1'.
- length of Supplemental data including prefix must be 5. Total required length is 21 for EAN-13 and 16 for EAN-8.
- Examples: add-on portion is highlighted data is underlined.

UPC-A 2-Digit add-on	'J'E00060992011187 <u>J'E1</u> <u>12</u> '
UPC-E 2-Digit add-on	'J'E00000000998875 <u>J'E1</u> <u>12</u> '
EAN-8 2-Digit add-on	'J'E400210126 <u>J'E1</u> <u>12</u> '
EAN-13 2-Digit add-on	'J'E01101234567891 <u>J'E1</u> <u>12</u> '

## 5-Digit Supplemental

- Supplemental data is appended to any EAN base label.
- Prefix must be ASCII characters 'J'E2'.
- Length of supplemental data including prefix must be 8. Total required length is 24 for EAN-13 and 19 for EAN-8.
- Examples: add-on portion is highlighted data is underlined.

UPC-A 5-Digit add-on	'J'E00060992011187 <u>J'E2</u> <u>12345</u> '
UPC-E 5-Digit add-on	'J'E00000000998875 <u>J'E2</u> <u>12345</u> '
EAN-8 5-Digit add-on	'J'E400210126 <u>J'E2</u> <u>12345</u> '
EAN-13 5-Digit add-on	'J'E01101234567891 <u>J'E2</u> <u>12345</u> '

## Bookland

- The 'Bookland' / ISBN code will be formatted as a vendor specific AIM label.
- Prefix must be ASCII characters 'J'X0'.
- length of label data including prefix is 13.
- Examples: 'J'X01234567890'.

## Code 39

- Check character must be included in label data.
- Label length including start, stop and check characters and excluding prefix characters must meet requirements imposed by the main scanner's fixed or variable label length control for this symbology type.
- Start and stop characters "\*" must be included in label.
- Prefix must be ASCII characters 'J'A0' or 'J'A1'.
- Example: '\*J'A0Code 39.TEST\*'.

## Codabar

- Check character must be included in label data.
- Label length including check character and excluding prefix characters must meet requirements imposed by the main scanner's fixed or variable label length control for this symbology type.
- Prefix must be ASCII characters 'J'F0'.

- Start stop character sets must meet the matching requirement set forth by the scanner configuration item *Start/Stop Character Match*.
- Start stop character sets must be of the form ABCD/ABCD and must be included in the label.
- Example: 'JF0s\$99.95s' (the lower case 's' at each end of the example is a placeholder for the start stop character set).

## MSI

- Check character must be included in label data.
- Label length including check character and excluding prefix characters must meet requirements imposed by the main scanner's fixed or variable label length control for this symbology type.
- Prefix must be ASCII characters 'JM0'.
- Example: 'JM0144769254'.

## Code 93

- Prefix must be ASCII characters 'JG0'.
- Label length excluding prefix characters must meet requirements imposed by the main scanner's fixed or variable label length control for this symbology type.
- Example : 'JG0Code93-test'.

## RSS-14

- Prefix must be ASCII characters 'je0'.
- Check character must be included in label.
- Label length excluding prefix characters must be 14 characters.
- Example: 'je001044123456789'.

## RSS Expanded

- Prefix must be ASCII characters 'je0'.
- Label length excluding prefix characters must be at least 1 character. Maximum length is the maximum label size supported by the scanner.
- Example: 'je001900123456789083103001750'.

## I 2 of 5

- Check character must be included in label data.
- Label length including check characters and excluding prefix characters must meet requirements imposed by the main scanner's fixed or variable label length control for this symbology type.
- Prefix must be an ASCII character 'J11' (other prefixes specify different check character properties which are not supported).
- Example: 'J110123456789'.

## Code 128 / EAN128

- Prefix must be either ASCII characters 'JC0', 'JC1' or 'JC2'.
- Label length excluding prefix character must meet requirements imposed by the main scanner's fixed or variable label length control for this symbology type.

- If EAN-128 Symbology is Enabled and prefix is 'JC1', label will be identified as an EAN128 otherwise it is identified as a Code 128.
- A prefix of 'JC0' designates that no function code is present in the 1st or 2nd character position.
- A prefix of 'JC2' designates that a function code 1 is present in the 2nd character.
- Example : 'JC0Code\_128.Test'.

### **PDF417**

- Prefix must be an ASCII characters 'L0'.
- Label length excluding prefix character cannot exceed 300 characters. In addition to this, label length excluding prefix character must meet requirements imposed by the main scanner's fixed or variable label length control for this symbology type.
- Example : 'L0pdf\_test\_label'.

### **"Unknown" AIM ID (an AIM ID which is not specified above)**

If a label is received that does not have an AIM ID as specified above, and the first three label characters qualify as follows...

- The first character is a '['
- The second character is a capital or small letter
- The third character is a digit

...then the label type is set to GENERIC\_DATA and the "unknown" AIM ID is left-appended to the beginning of the label data.

## ASCII Character Set

The table on this page shows a set of ASCII characters and their corresponding Hex Values. The Hex Values in this table are needed for setting symbology specific label identifiers, as well as enabling custom prefix and suffix characters.

ASCII Char.	Hex No.	ASCII Char.	Hex No.	ASCII Char.	Hex No.	ASCII Char.	Hex No.
NUL	00	SP	20	@	40	'	60
SOH	01	!	21	A	41	a	61
STX	02	"	22	B	42	b	62
ETX	03	#	23	C	43	c	63
EOT	04	\$	24	D	44	d	64
ENQ	05	%	25	E	45	e	65
ACK	06	&	26	F	46	f	66
BEL	07	'	27	G	47	g	67
BS	08	(	28	H	48	h	68
HT	09	)	29	I	49	i	69
LF	0A	*	2A	J	4A	j	6A
VT	0B	+	2B	K	4B	k	6B
FF	0C	,	2C	L	4C	l	6C
CR	0D	-	2D	M	4D	m	6D
SO	0E	.	2E	N	4E	n	6E
SI	0F	/	2F	O	4F	o	6F
DLE	10	0	30	P	50	p	70
DC1	11	1	31	Q	51	q	71
DC2	12	2	32	R	52	r	72
DC3	13	3	33	S	53	s	73
DC4	14	4	34	T	54	t	74
NAK	15	5	35	U	55	u	75
SYN	16	6	36	V	56	v	76
ETB	17	7	37	W	57	w	77
CAN	18	8	38	X	58	x	78
EM	19	9	39	Y	59	y	79
SUB	1A	:	3A	Z	5A	z	7A
ESC	1B	;	3B	[	5B	{	7B
FS	1C	<	3C	\	5C		7C
GS	1D	=	3D	]	5D	}	7D
RS	1E	>	3E	^	5E	~	7E
US	1F	?	3F	_	5F	DEL	7F



© 2016-2019 Datalogic S.p.A. and/or its affiliates ▪ All rights reserved. ▪ Without limiting the rights under copyright, no part of this documentation may be reproduced, stored in or introduced into a retrieval system, or transmitted in any form or by any means, or for any purpose, without the express written permission of Datalogic S.p.A. and/or its affiliates ▪ Datalogic and the Datalogic logo are registered trademarks of Datalogic S.p.A. in many countries, including the U.S. and the E.U.



[www.datalogic.com](http://www.datalogic.com)

**Datalogic S.r.l.**

Via S. Vitalino, 13 | 40012 Calderara di Reno | Bologna - Italy  
Tel. +39 051 3147011 | Fax +39 051 3147205



820089214

(Rev. B)

Mar 2019